

# **École Pratique des Hautes Études**

Mention « Systèmes Intégrés, Environnement et Biodiversité »

Pour l'obtention du grade de Docteur

Spécialité : Écologie marine

Présentée par Géraldine CRIQUET

## **Variabilité spatiale et temporelle de la structure des peuplements ichthyques exploités à la Martinique : Impacts des réserves marines de pêche**

Dirigée par Philippe LENFANT

Soutenue publiquement le 24 septembre 2009

Jury

Eric Feunteun	Examineur
Philippe Lenfant	Directeur
Bertrand Gobert	Examineur
Raquel Goñi	Examineur
Raymonde Lecomte	Examineur
Lionel Reynal	Examineur
Patrice Francour	Rapporteur
Jocelyne Ferraris	Rapporteur

École Doctorale de l'École Pratique des Hautes Études  
Mention *Systèmes Intégrés, Environnement et Biodiversité*  
Thèse de Doctorat  
Spécialité : *Écologie marine*

Présentée par Géraldine CRIQUET

**Variabilité spatiale et temporelle de la structure des  
peuplements ichthyques exploités à la Martinique :  
Impacts des réserves marines de pêche**

Sous la direction de  
Philippe LENFANT  
UMR 5244 CNRS EPHE UPVD  
Biologie et Écologie Tropicale et Méditerranéenne  
Université de Perpignan, 66000 Perpignan

Soutenue publiquement le 24 septembre 2009

Devant un jury composé de :

Eric Feunteun	Examineur
Philippe Lenfant	Directeur
Bertrand Gobert	Examineur
Raquel Goñi	Examineur
Raymonde Lecomte	Examineur
Lionel Reynal	Examineur
Patrice Francour	Rapporteur
Jocelyne Ferraris	Rapporteur



*À ma mère.*



Le Grand Fossé / GRAN KANNAL LA

©1980 Les Éditions Albert René / GOSCINNY-UDERZO

©2008 Les Éditions Albert René / GOSCINNY-UDERZO Publié par  
CARAÏBEDITIONS Traduction en créole de Hector Poulet et Jean Marc Rosier

## REMERCIEMENTS

Mes remerciements s'adressent en premier lieu au Président du Conseil Régional de la Martinique, Alfred MARIE-JEANNE, pour le financement de ce travail. Au sein du Conseil Régional, je remercie vivement Marie-Christine VARTEL, Gertrude BOIS DE FER et Sylvain BOLINOIS pour leur disponibilité et leur soutien dans les différentes démarches administratives.

Je remercie ensuite le professeur René Galzin pour son accueil au sein de son laboratoire à Perpignan.

Je remercie chaleureusement Philippe LENFANT qui m'a encadrée tout au long de ces années. Merci pour ta confiance, ton soutien, ta disponibilité, nos nombreux échanges scientifiques ou pas au laboratoire, sur le terrain, sur la route, en Congrès.... J'admire tes valeurs humaines, scientifiques, ton respect de l'autre, ton énergie, ton entrain qui dessinent une image particulièrement belle du métier de chercheur...Reçois ici le témoignage de mon affection et de ma reconnaissance.

Ce travail n'aurait pu avoir lieu sans la coopération de l'Observatoire du Milieu Marin Martiniquais et de l'IFREMER Martinique. Je remercie donc Jean-Philippe MARÉCHAL, Lionel REYNAL et Jacques BERTRAND pour votre accueil lors des missions d'échantillonnage, votre implication technique, logistique, administrative dans le projet, vos conseils judicieux et votre sympathie. Je tiens également à remercier tout le personnel de la station IFREMER du Robert pour leur sympathie et pour avoir égayer les longues et fatigantes journées de prélèvement au laboratoire !

Je remercie également Raymonde LECOMTE-FINIGER qui m'a initiée à l'étude des otolithes et qui m'a transmise sa passion. Raymonde, merci pour tes encouragements, ta bonne humeur, ton énergie positive, ta disponibilité et ton soutien particulièrement lors de ces derniers mois difficiles. Reçois ici le témoignage de mon affection et de mon amitié.

Je tiens également à remercier Camille ETNA pour la fabrication des nasses expérimentales. Un grand merci à Alphonse ALTIUS et Louis BELVENT, pêcheurs des Trois-Ilets et du Robert avec lesquels les pêches expérimentales ont été réalisées. Je vous remercie pour votre infinie patience et vos précieux conseils. Ces longues heures passées en mer à relever les nasses tout en regardant le soleil se lever sur la Baie du Robert, les rideaux de pluie *monté-désann* de la Baie de Fort-de-France, les fous rires malgré la fatigue, les gestes ancestraux des pêcheurs.....tous ces moments sont inoubliables.

Mes remerciements viennent ensuite à Jessica GARCIA. Ah Jess, qu'aurais-je fait sans toi !! Toi qui m'as accompagnée pendant ces deux années de terrain ! Les nasses, les pêches expérimentales, la mangrove, les poissons, les otolithes....épuisées, couvertes de

boue, trempées, bouffées par les moustiques et les yin-yins mais ta motivation n'a jamais flanché. Je te souhaite de réussir....

Merci aussi aux thésards basés à l'OMMM, Hélène, Yann et Laurent. Merci pour tous les moments partagés, les coups de main, votre amitié et votre sympathie qui ont rendu d'autant plus chouettes les missions en Martinique.

Je tiens à exprimer mes remerciements aux statutaires, étudiants et stagiaires de l'UMR 5244 CNRS-EPHE-UPVD à Perpignan pêle-mêle : Bruno DELESALLE pour son infailible soutien, Irma et Jocelyne les « magiciennes » des départs en missions, Romain, Medhi, Muriel, Joachim « funky man » pour nos nombreuses discussions stats et poisson, Caroline, Rita Véronique, Jérémie, Jérémy, Lucie, Matthias pour nos discussions-fleuve et pour ta participation orale aux heures de ponçage des otolithes, Suzie, Aurore, Pablo, Vanessa pas assez souvent à Perpignan, Elisabeth, Jean-Olivier, Jérôme, Benjamin, Marion, Gilles, Guillaume, Géraldine, Julie, Anne, Julien, Rémy, Jean-Luc, Sarah, Florence, Chirine, Fabien avec une pensée spéciale pour Carmen, Céline et Elsa pour votre soutien et bien plus encore pendant ces derniers mois éprouvants...

Je remercie également Jocelyne FERRARIS et Michel KULBICKI de l'IRD pour leur disponibilité et leurs conseils judicieux sur le traitement des données.

Je tiens à remercier tous les amis proches et éloignés géographiquement, d'ici et d'ailleurs pour leurs encouragements et pour m'avoir beaucoup donné et pas seulement durant ces années de thèse...

Merci à ma famille pour leur affection, leur amour, leur soutien inconditionnel et pour tout le reste !!!

Merci à mon compagnon de voyage, le plus beau des voyages.....Jean-Luc merci pour ta patience, tes encouragements, ton soutien à tous les stades de ce travail même pendant les coups durs. Je n'oublie pas Emmanuel et Laura, leurs rires, leurs sourires et leur affection sont une source inépuisable d'énergie et de bonheur.

## RÉSUMÉ

La plupart des stocks mondiaux sont surexploités et on assiste à un déclin des pêcheries, source de nourriture importante et activité économique principale de millions de personnes. Les Aires Marines Protégées (AMP) sont de plus en plus plébiscitées comme outils de protection des ressources, de maintien durable et de gestion des pêcheries. Le but de ce travail est d'évaluer l'impact de la protection sur la structure des communautés ichthyiques exploitées à la Martinique. Des pêches expérimentales aux nasses ont été effectuées pendant deux ans à l'intérieur et à l'extérieur de deux cantonnements de pêche. Les captures totales, les captures spécifiques et les tailles moyennes sont supérieures dans les zones protégées. Mais certaines espèces comme les herbivores, les espèces de grande taille et les espèces sédentaires, répondent plus fortement à la protection et la performance des cantonnements n'est pas la même. Nos résultats suggèrent que les communautés de poissons sont plus stables au cours du temps au sein des zones protégées. Ce travail fournit des résultats encourageants concernant l'utilisation de cantonnements de pêche pour la protection des ressources. Mais l'efficacité des cantonnements dépend également de la régulation de l'effort de pêche dans les zones exploitées adjacentes.

**Mots-clés :** réserve marine de pêche – nasses – pêches expérimentales – poissons récifaux – otolithe – analyses multivariées - Martinique

## ABSTRACT

Coral reefs associated small-scale fisheries are essential for food supplies and economical and cultural activities of many countries. Most of marine resources are overexploited worldwide. Marine Protected Areas (MPA) are increasingly considered as an efficient instrument for resource protection and fisheries management. In this study, we evaluate the protection effects on exploited reef fish assemblages in Martinique. A two-year survey was conducted using experimental traps inside and outside two fishery reserves. Higher total catches, species catches and mean length were obtained inside both reserves. Some species responded stronger to protection, especially herbivorous species, large body-size fishes and sedentary species and the two fishery reserves performed differently. Our results suggested that fish communities were more stable inside the protected areas over time. This study provides encouraging results on the use of fishery reserves for protecting resources. We have also highlighted that the success of fishery reserves in sustaining coastal small-scale fisheries depends on a regulation of the fishing effort in the surrounding fishing zones.

**Key words:** fishery reserve – traps – experimental fishing – reef fishes – otolith – multivariate analysis - Martinique

## **LISTE DES TABLEAUX**

### **Chapitre I : INTRODUCTION**

<b>Tableau 1.</b> Synthèse des hypothèses avec les chapitres correspondant	15
--	----

### **Chapitre II : SITES ET MÉTHODES**

<b>Tableau 2.</b> Indices de forme (facteur de forme, rondeur, circularité, rectangularité et ellipticité)	25
--	----

### **Chapitre III : Response of exploited Caribbean reef fishes to protection**

<b>Table 1.</b> Main characteristics of the Caribbean and the Atlantic studied fishery reserves (FRs)	59
<b>Table 2.</b> Four-way ANOVAs table of total catches and catches of species groups	60
<b>Table 3.</b> Repeated-measures ANOVAs table of total catches and catches of species groups inside and outside the Atlantic fishery reserve	61
<b>Table 4.</b> Repeated-measures ANOVAs table of total catches and catches of species groups inside and outside the Caribbean fishery reserve	62
<b>Table 5.</b> Protection index (FR:FZ ratio) for species groups for each location	62

### **Chapitre IV : Catch-length structure of reef fishes as an indicator of the protection effects in Martinique**

<b>Table 1.</b> Main characteristics of the studied fishery reserves	94
<b>Table 2.</b> Species composition (species representing 1% and more than 1% of total catch) of overall catches (number of fishes caught) inside and outside Ilet à Ramier and Baie du Robert fishery reserves. The number of species caught for each location is noticed in brackets	95
<b>Table 3.</b> Minimum, maximum and mean length (cm), with standard deviation in brackets, of the more common species caught in traps inside (FR) and outside (FZ) the fishery reserves with results of Mann-Whitney test comparing differences between FR and FR.	96-97
<b>Table 4.</b> Size (cm) at first maturity of target species established from the present data set, and by <sup>a</sup> Hawkins et al. (2007) in St-Lucia and <sup>b</sup> Munro (1983) in Jamaica from fishes caught in traps. TP and IP are terminal phase and initial phase, respectively	98

### **Chapitre V : Age and growth of the Caribbean redband parrotfish *Sparisoma aurofrenatum* inside and outside a protected area**

<b>Table 1.</b> Growth parameters and Fulton coefficient inside (FR) and outside (FZ) the protected area. The difference in Fulton coefficient between inside and outside was significant (p=0.05)	104
<b>Table 2.</b> Mean length (cm) at age inside (FR) and outside (FZ) the protected area	104



**Chapitre VI : Discrimination of Caribbean redband parrotfish (*Sparisoma aurofrenatum*) from protected and unprotected areas using otolith shape**

**Table 1.** Otolith shape indices used in this study 114

**Table 2.** Shape indices for otolith of *Sparisoma aurofrenatum* at different sites and season. Values are mean $\pm$ SE 114

## LISTE DES FIGURES

### Chapitre I : INTRODUCTION

- Figure 1.** Déclin des débarquements des pêcheries marines mondiales à partir de la fin des années 1980 (D'après Pauly et al., 2003). 10
- Figure 2.** Distribution des poissons entre les zones protégées et non protégées : a) quand les espèces ont une mobilité et une capturabilité équivalentes ; b) quand la mobilité diffère entre les espèces mais pas la capturabilité ; c) quand la capturabilité diffère entre les espèces mais pas la mobilité (D'après Rakitin et Kramer, 1996). 12

### Chapitre II : SITES ET MÉTHODES

- Figure 3.** Situation géographique de la Martinique. Les formations coralliennes sont représentées en orange (réalisée à partir d'une carte d'Hélène Legrand) 18
- Figure 4.** Localisation des cantonnements de la Baie du Robert (A) et de l'Ilet à Ramier (B) 20
- Figure 5.** Schéma du protocole d'échantillonnage. Ce protocole est mis en œuvre pendant les deux saisons d'échantillonnage réalisées en 2007 et 2008. CA : cantonnement ; NC : zone non protégée ; Na : nasse. 21
- Figure 6.** Appareil vestibulaire 22
- a) Vue dorsale de l'appareil vestibulaire
- b) Les trois paires d'otolithes à l'intérieur du système labyrinthaire de poisson. Sag : sagitta ; Sac : saccule ; Lap : lapillus ; Utr : utricule ; Ast : astericus ; Lag : lagena (D'après Panfili et al., 2002)
- Figure 7.** Extraction des *sagittae* (du Labridae *Bodianus rufus*) et leur transfert dans des coupelles contenant de l'eau distillée 23
- Figure 8.** Descripteurs de distance mesurés sur l'image binarisée d'une *sagittae* 24
- Figure 9.** Schématisation des résultats attendus par l'utilisation de la transformée de Fourier sur un contour fermé à k points 27
- Figure 10.** Les trois plans classiques de section des *sagittae* (Panfili et al., 2002) 29
- Figure 11.** Lame mince obtenue après ponçage d'un otolithe de *Sparisoma aurofrenatum* 30
- Figure 12.** Schéma récapitulatif des différentes méthodes et analyses réalisées au cours de ce travail pour évaluer l'effet de la protection sur les communautés de poissons exploités 31

### Chapitre III : Response of exploited Caribbean reef fishes to protection

- Figure 1.** Map of the network of FRs of Martinique showing the studied FRs and the sampling sites 64
- Figure 2.** Schema summarizing environmental and anthropogenic events occurred in the Atlantic and the Caribbean locations during the two-year survey 65

**Figure 3.** Multivariate regression tree showing the hierarchical organization of effects of Protection, Location, Year and Season on catches. The number of fishing events was reported for each split and each leaf. 66

**Figure 4.** Boxplots of (A) total catches, of catches of (B) Acanthuridae, (C) Scaridae, (D) Lutjanidae, (E) Haemulidae, (F) macrocarnivorous, (G) microcarnivorous, (H) herbivorous, (I) sedentary fishes, (J) mobile fishes, (K) small fishes, (L) medium fishes, (M) large fishes, (N) larger fishes, (O) fishes with low fishing value, (P) fishes with medium fishing value, and (Q) fishes with high fishing value for each location, each year, each season and each level of protection (white boxes: FZ and hatched boxes: FR). Results of one-way ANOVAs comparing differences between the FR and FZ for each season, each year and each location are given (ns: no significant, \* $p < 0.05$ , \*\* $p < 0.01$ , \*\*\* $p < 0.001$ ) 67-75

#### **Chapitre IV : Catch-length structure of reef fishes as an indicator of the protection effects in Martinique**

**Figure 1.** Map of the network of protected areas in Martinique showing the studied fishery reserves (A: Baie du Robert B: Ilet à Ramier) and the sampling sites. 90

**Figure 2.** The double-funnel Antillean-Z trap (from Mahon and Hunte 2001). 91

**Figure 3.** Length-frequency distribution of overall catch in Ilet à Ramier fishery reserve (IRFR) and fishing zone (IRFZ) and in Baie du Robert fishery reserve (BRFR) and fishing zone (BRFZ). 91

**Figure 4.** Length-frequency distribution of *Acanthurus bahianus*, *A. chirurgus*, *Sparisoma aurofrenatum*, *S. chrysopterum*, *S. viride*, *Mulloidichthys martinicus*, *Holocentrus rufus*, *Haemulon flavolineatum*, *Ocyurus chrysurus*, *Lutjanus synagris* and *Cephalopholis fulva* inside and outside the fishery reserves. 92-93

#### **Chapitre V : Age and growth of the Caribbean redband parrotfish *Sparisoma aurofrenatum* inside and outside a protected area**

**Figure 1.** Map of the study area. A is the Ilet à Ramier fishery reserve where fishes were caught. 103

**Figure 2.** Relation between length and age for *Sparisoma aurofrenatum*. Data are fitted to the von Bertalanffy equation  $L_t = L_\infty \times (1 - \exp^{-K(t-t_0)})$ .  $N(\text{FR})=44$  et  $N(\text{FZ})=23$ . 103

**Figure 3.** Age-frequency distribution of *Sparisoma aurofrenatum* inside (black bars) and outside (white bars) Ilet à Ramier fishery reserve. 104

#### **Chapitre VI : Discrimination of Caribbean redband parrotfish (*Sparisoma aurofrenatum*) from protected and unprotected areas using otolith shape**

**Figure 1.** Location of sampling sites: A is Ilet à Ramier and B is Baie du Robert 115

**Figure 2.** Number of fish of initial phase (IP) and terminal phase (TP) in March and October 115

**Figure 3.** IP length frequency distribution in March 116

**Figure 4.** IP length frequency distribution in October 116

<b>Figure 5.</b> TP length frequency distribution in March	116
<b>Figure 6.</b> TP length frequency distribution in October	116
<b>Figure 7.</b> Number of fish of initial phase (IP) and terminal phase (TP) in no-take zone (NTZ) and fishing zone (FZ)	117
<b>Figure 8.</b> IP length frequency distribution in NTZ of Caribbean coast	117
<b>Figure 9.</b> IP length frequency distribution in FZ of Caribbean coast	117
<b>Figure 10.</b> TP length frequency distribution in NTZ of Caribbean coast	118
<b>Figure 11.</b> TP length frequency distribution in FZ of Caribbean coast	118
<b>Figure 12.</b> Number of fish of initial phase (IP) and terminal phase (TP) in no-take zone (NTZ) and fishing zone (FZ)	118
<b>Figure 13.</b> IP length frequency distribution in NTZ of Atlantic coast	119
<b>Figure 14.</b> IP length frequency distribution in FZ of Atlantic coast	119
<b>Figure 15.</b> TP length frequency distribution in NTZ of Atlantic coast	119
<b>Figure 16.</b> TP length frequency distribution in FZ of Atlantic coast	119
<b>Figure 17.</b> Discrimination between otoliths of <i>Sparisoma aurofrenatum</i> from different season and site ( $\lambda < 0.001$ )	120
<b>Figure 18.</b> Discrimination between otolith of <i>Sparisoma aurofrenatum</i> from protected and unprotected areas of Caribbean and Atlantic sites in March ( $\lambda < 0.001$ )	120
<b>Figure 19.</b> Discrimination between otolith of <i>Sparisoma aurofrenatum</i> from protected and unprotected areas of Caribbean and Atlantic sites in October ( $\lambda < 0.001$ )	121

## **Chapitre VII : DISCUSSION GÉNÉRALE**

<b>Figure 13.</b> Répartition de l'effort de pêche dans les zones exploitées voisines des cantonnements de la Baie du Robert (A) et de l'Ilet à Ramier (B).	127
---	-----

<b>CHAPITRE I : INTRODUCTION</b>	<b>8</b>
<b>CHAPITRE II : SITES ET MÉTHODES</b>	<b>16</b>
<b>1. PRÉSENTATION GÉNÉRALE DE LA MARTINIQUE</b>	<b>17</b>
<b>1.1. CADRE GÉOGRAPHIQUE</b>	<b>17</b>
<b>1.2. FACTEURS ENVIRONNEMENTAUX</b>	<b>18</b>
1.2.1. Le climat	18
1.2.2. Les vents et la houle	19
<b>1.3. CADRE HALIEUTIQUE</b>	<b>19</b>
<b>2. PRÉSENTATION DES CANTONNEMENTS ÉTUDIÉS ET DES MÉTHODES</b>	<b>19</b>
<b>2.1. CANTONNEMENTS</b>	<b>19</b>
2.1.1. La Baie du Robert	20
2.1.2. L'Ilet à Ramier	21
<b>2.2. ÉCHANTILLONNAGE</b>	<b>21</b>
<b>2.3. OTOLITHE</b>	<b>22</b>
2.3.1. Généralités	22
2.3.2. Extraction	23
2.3.3. Morphologie des otolithes	24
2.3.3.1. Numérisation des <i>sagittae</i>	24
2.3.3.2. Descripteurs de distance et indices de forme	24
2.3.3.3. Analyse du contour de la <i>sagittae</i> : analyse de Fourier elliptique	25
2.3.4. Otolithométrie	28
2.3.4.1. Préparation des lames minces	28
2.3.4.2. Age et croissance	29
<b>CHAPITRE III : Response of exploited Caribbean reef fishes to protection</b>	<b>32</b>
<b>CHAPITRE IV: Catch-length structure of reef fishes as an indicator of the protection effect in Martinique</b>	<b>76</b>
<b>CHAPITRE V: Age and growth of the Caribbean redband parrotfish <i>Sparisoma aurofrenatum</i> inside and outside a marine reserve</b>	<b>99</b>
<b>CHAPITRE VI : Discrimination of Caribbean redband parrotfish (<i>Sparisoma aurofrenatum</i>) from protected and unprotected areas using otolith shape</b>	<b>107</b>
<b>CHAPITRE VII : DISCUSSION GÉNÉRALE</b>	<b>122</b>
<b>BIBLIOGRAPHIE</b>	<b>131</b>
<b>ANNEXES</b>	<b>148</b>

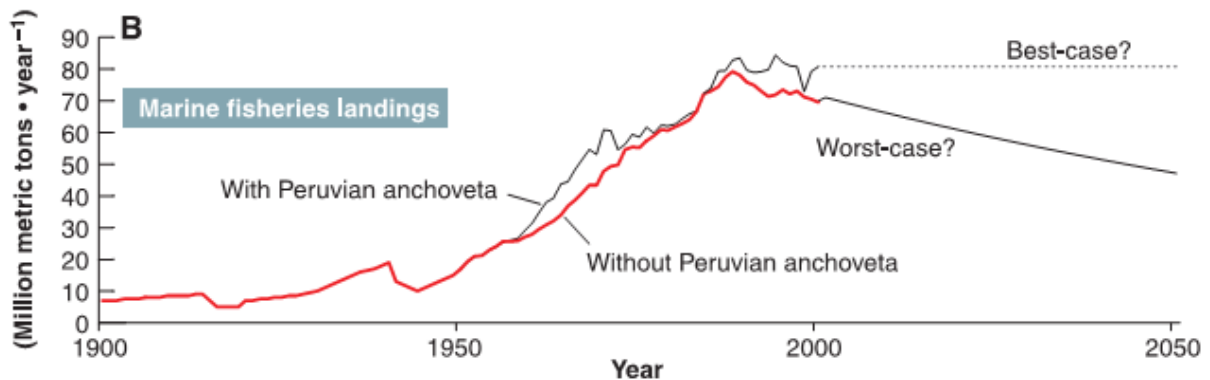
# **CHAPITRE I**

## **INTRODUCTION**

“*F*ishing is the catching of aquatic wildlife, the equivalent of hunting bison, deer and rabbits on land” (Pauly et al 2002)

Cette définition de la pêche par Pauly et al. (2002) illustre bien l'importance de cette activité qui nourrit des millions de personnes des zones arctiques aux régions tropicales et ce, depuis des millénaires. En effet, la plus vieille capture connue de poissons marins daterait de 32000 ans avant J.-C. dans l'actuelle Papouasie-Nouvelle Guinée (Dazell, 1998). De nombreuses analyses de données archéologiques ont révélé une exploitation continue des ressources marines par les populations humaines préhistoriques dans la Caraïbe (Wing et Wing, 2001), dans les îles du Pacifique (Dazell, 1998) ou encore sur les côtes de la Californie (Rick et Erlandson, 2000). Ces mêmes études archéologiques ont montré une diminution de la taille moyenne des espèces cibles ainsi que des changements dans la structure trophique des communautés indiquant une surexploitation précoce des ressources (Leach et Davidson, 2001; Wing et Wing, 2001). L'accroissement démographique notamment dans les régions littorales où sont localisés les récifs coralliens, l'augmentation de l'effort de pêche et l'amélioration de la performance des engins de pêche au cours du temps font qu'aujourd'hui, la surexploitation des ressources est considérée comme étant l'activité anthropique qui impacte le plus les écosystèmes marins côtiers (Jackson et al., 2001). Une abondante littérature décrit les effets directs de la surpêche sur la structure des communautés de poissons et indirects sur les écosystèmes. En général, une diminution de l'abondance et de la diversité des espèces cibles est observée, cette diminution ayant été corrélée avec l'intensité de l'exploitation par Jennings et al. (1995) aux Seychelles, par Russ et Alcala(1989) aux Philippines ou encore par Hawkins et Roberts (2004) dans la Caraïbe. Des changements dans le spectre de taille des espèces ont été également observés avec un déclin des espèces prédatrices de grande taille (Bianchi et al., 2000; Graham et al., 2005) et une diminution de la taille moyenne des espèces cibles (Hawkins et Roberts, 2003). Une analyse de Myers et Worm (2003) suggère une perte de 90% des grands poissons prédateurs au niveau mondial. De ce fait, une autre conséquence de la surpêche est l'apparition de changements dans la structure trophique des communautés (Jennings et Polunin, 1997; Friedlander et DeMartini, 2002) dont le niveau trophique moyen a diminué. La surexploitation peut également induire des effets indirects sur les communautés benthiques récifales en participant aux processus de diminution de la couverture corallienne (McClanahan, 1995; Hughes et al., 2003; Bellwood et al., 2004; Dulvy et al., 2004a).

Les effets décrits précédemment ont entraîné un déclin des captures et des rendements des pêcheries (Fig. 1) à la fin des années 1980 (Koslow et al., 1988; Pauly, 1995, 2009) hypothéquant la sécurité alimentaire et l'activité économique de régions à pression démographique croissante donc ayant une demande alimentaire accrue telles que les régions récifales.



**Figure 1.** Déclin des débarquements des pêcheries marines mondiales à partir de la fin des années 1980 (D'après Pauly et al., 2003).

Les mesures traditionnelles de gestion (quotas, limitation de l'effort de pêche, tailles minimales de capture) n'assurant pas la pérennité des pêcheries (Pauly et al., 2002), les Aires Marines Protégées (AMP) sont de plus en plus plébiscitées comme outils de protection des ressources, de maintien durable et de gestion des pêcheries (Roberts et al., 2001; Pauly et al., 2005).

Une AMP ou réserve se définit comme « *Tout domaine intertidal ou subtidal, avec la couche d'eau qui le recouvre, la flore et la faune associées, ainsi qu'avec ses caractéristiques historiques et culturelles, qui a été réservé, réglementairement ou par d'autres moyens, pour protéger tout ou partie de l'environnement qu'il délimite* » (IUCN, 1988)

Les AMP dérivent de concepts et de théories préalablement développés et appliqués en milieu terrestre (Carr et al., 2003). Ainsi 12,2% des terres sont protégées contre seulement 0,5% de la surface totale des océans (Chape et al., 2005).

Les effets écologiques des AMP sur les communautés de poissons sont bien documentés. Généralement, une augmentation des abondances, des densités et des tailles

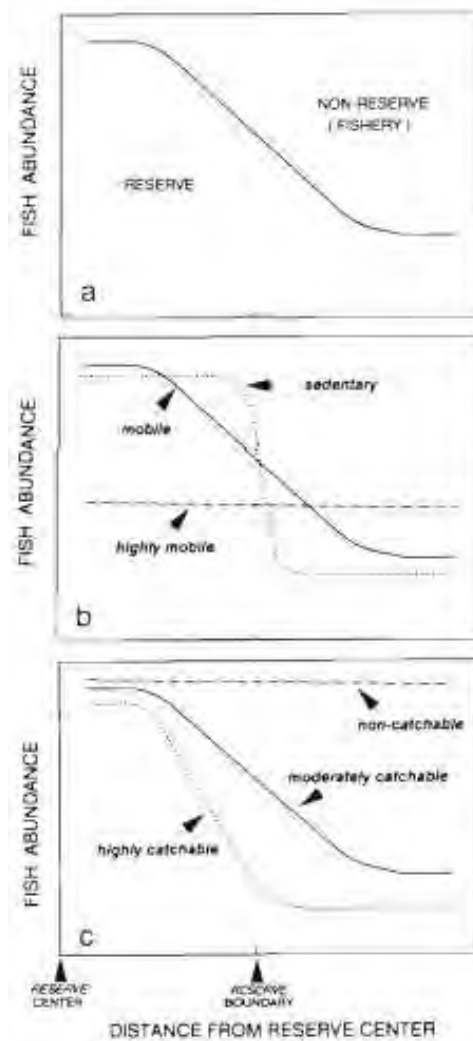


moyennes sont observées suite à l'établissement des zones protégées ainsi que des différences entre zones protégées et zones adjacentes exploitées. Roberts (1995) rapporte une augmentation de 220% de la biomasse des Lutjanidae suite à la création du parc marin de l'île de Saba. Des travaux de McClanahan et Arthur (2001) indiquent des abondances d'Acanthuridae et de Scaridae supérieures dans des AMP de l'Afrique Orientale. Une étude de Rakitin et Kramer (1996) montre que la taille moyenne de nombreuses espèces exploitées est supérieure au sein de la réserve marine de l'île de la Barbade. Les espèces de Serranidae de grande taille ont de plus fortes densités dans des AMP de la Caraïbe (Chiappone et al., 2000) que dans des zones exploitées. Une étude de Friedlander et al. (2007) indique des biomasses totales et des abondances de prédateurs supérieures à l'intérieur d'AMP à Hawaï. Différentes techniques sont appliquées pour la collecte des données en vue de l'évaluation de l'effet de la protection en fonction des objectifs et des hypothèses de départ. La plupart des études utilisent les comptages visuels sous-marins (Polunin et Roberts, 1993; Wantiez et al., 1997; Russ et Alcala, 1998; Ferraris et al., 2005; McClanahan et Graham, 2005; Hawkins et al., 2006; Kulbicki et al., 2007; Ojeda-Martinez et al., 2007; Forcada et al., 2008; Harmelin-Vivien et al., 2008), alors que peu utilisent les pêches expérimentales (Rakitin et Kramer, 1996; Kaunda - Arara et Rose, 2004; Forcada et al., 2009), les données de captures des pêcheries (Murawski et al., 2005; Stelzenmüller et al., 2007; Goñi et al., 2008; Mouillot et al., 2008) et les vidéos sous-marines (Willis et al., 2000; Denny et Babcock, 2004).

Cependant, les processus par lesquels les pêcheries avoisinantes bénéficieraient de l'établissement d'AMP restent encore difficiles à appréhender. Le maintien et /ou l'amélioration des pêcheries environnantes résulteraient de l'exportation nette de biomasse via la migration d'adultes et de recrues des zones protégées vers les zones exploitées, processus appelé « spillover ». Certains travaux, se basant sur un suivi temporel des CPUE (captures par unité d'effort), ont observé une augmentation des CPUE des espèces cibles suite à la création d'AMP (McClanahan et Kaunda - Arara, 1996; Russ et al., 2003; Williams et al., 2009) . D'autres, en analysant les gradients de CPUE, ont montré une corrélation négative entre les CPUE et la distance depuis les limites des zones protégées (Kaunda - Arara et Rose, 2004; Goñi et al., 2008; Williams et al., 2009).

Les bénéfices de la protection pour les pêcheries dépendent de la réponse des espèces à la protection qui diffère en fonction du comportement, des traits d'histoire de vie et du niveau d'exploitation des espèces (Gerber et al., 2002; Micheli et Halpern, 2005). Selon Mosqueira et al. (2000), les espèces de grande taille intensivement exploitées répondent fortement à la

protection ; de plus Botsford et al. (2003) suggèrent que les AMP offrent une protection plus efficace aux espèces sédentaires et peu mobiles (Fig. 2).



**Figure 2.** Distribution des poissons entre les zones protégées et non protégées : a) quand les espèces ont une mobilité et une capturabilité équivalentes ; b) quand la mobilité diffère entre les espèces mais pas la capturabilité ; c) quand la capturabilité diffère entre les espèces mais pas la mobilité (D'après Rakitin et Kramer, 1996).

Cependant, les caractéristiques biologiques et écologiques ne sont pas les seules composantes à jouer un rôle dans la réponse des espèces à la protection. D'autres facteurs tels que les facteurs environnementaux et sociaux-culturels sont susceptibles d'influencer l'impact des AMP sur les communautés de poissons exploités (Garcia-Charton et Pérez-Rufaza, 1999; García-Charton et al., 2004; Oracion et al., 2005). Il arrive souvent que les effets observés divergent des effets attendus. Ainsi, dans certains cas, des espèces pourtant fortement exploitées ne répondent pas ou répondent négativement à la protection (Denny et Babcock,

2004; Ainsworth et al., 2008). L'analyse des effets de la protection est nécessaire afin d'évaluer si les AMP répondent aux objectifs pour lesquels elles ont été mises en place (Claudet, 2006).

La surexploitation de la plupart des stocks de la région Caraïbe est avérée (Koslow et al., 1988; Hawkins et Roberts, 2004). La Martinique n'échappe pas à ce constat et présente les caractéristiques des zones côtières en surpêche. La pression démographique y est forte, la consommation de produits issus de la pêche est importante (environ 50 kg/habitant/an) et associée à un pouvoir d'achat élevé (Ramdine, 2004), induisant une forte pression de pêche 10 à 20 fois supérieure à celle des îles voisines (Gobert, 2000). Ainsi, face au déclin alarmant des pêcheries côtières au cours des dernières décennies, le Comité Régional des Pêches et des Élevages Maritimes et la Commission Pêche du Conseil Régional ont décidé de mettre en place un réseau d'AMP sous la forme de réserves intégrales de pêche ou cantonnements de pêche (voir Annexe). Huit cantonnements de pêche de taille variable et protégeant des habitats essentiels ont été créés entre 1999 et 2005. Ceci, dans un but de maintien durable de l'activité de pêche à travers la protection des populations adultes, la protection des sites de pontes et des nurseries (Maréchal, 2007).

Bien que le premier cantonnement ait été implanté il y a 10 ans, aucune étude n'a encore évalué l'impact de la protection sur les communautés de poissons et sur les pêcheries. Il n'existe pas non plus de point de référence avant la mise en réserve permettant d'étudier d'une part l'évolution temporelle des communautés à l'intérieur et à l'extérieur des AMP et des captures dans les zones exploitées environnantes ; et d'autre part de faire des comparaisons entre les AMP et les zones exploitées suivant la procédure BACI (Before After Control Impact), qui est la plus appropriée pour séparer les effets de la protection des variations naturelles spatiales et temporelles des communautés (Fraschetti et al., 2002).

C'est dans ce contexte que s'inscrit cette thèse. Ce travail, qui analyse la structure des peuplements ichthyiques à l'intérieur et à l'extérieur d'AMP, a deux objectifs globaux. D'une part, il s'agit de fournir les premiers résultats sur l'impact de la protection et d'autre part, sur la base de ces résultats, de soumettre aux autorités compétentes des propositions visant à améliorer la gestion des ressources côtières martiniquaises.

Ce travail, dont la récolte des données est réalisée par des pêches expérimentales, s'articule autour de deux axes comportant diverses hypothèses.

### **AXE 1 : Analyse des captures**

- 1) L'abondance des espèces exploitées étant corrélée avec l'intensité de l'exploitation, on part de l'hypothèse que les captures totales et les captures spécifiques sont supérieures dans les zones protégées.
- 2) La surpêche ayant une incidence sur les spectres de taille et la taille moyenne des espèces, la structure de taille des captures est différente entre les zones protégées et non protégées avec des poissons de plus grande taille et des tailles moyennes supérieures dans les cantonnements.
- 3) La réponse des espèces à la protection diffère en fonction de critères biologiques, comportementaux et d'exploitation. Les espèces à forte valeur commerciales, intensivement exploitées et sédentaires réagissent fortement à la protection.
- 4) Les cantonnements sont différents surtout de part leur taille, leur localisation (côte atlantique ou caraïbe) et les habitats qu'ils protègent. Les facteurs environnementaux influencent la répartition et la structure des communautés de poissons (Mellin et al., 2008) et l'effet de la protection augmente avec la taille de la réserve (Claudet et al., 2008). Ainsi, les espèces réagissant à la protection diffèrent entre les cantonnements et la performance des cantonnements n'est pas similaire.

### **AXE 2 : Analyse de l'otolithe**

- 1) La surpêche diminue la taille moyenne des espèces, or il y a une bonne corrélation entre l'âge et la taille chez les Scaridae (Choat et al., 1996). On considère donc qu'au sein des cantonnements, l'âge maximum atteint par une espèce de Scaridae est supérieur avec une croissance initiale plus lente qu'en zone non protégée.
- 2) La forme de l'otolithe est caractéristique d'une espèce (L'Abée-Lund, 1988) mais des variations intra-spécifiques liées aux facteurs environnementaux sont observées (Friedland et Reddin, 1994). Cette propriété est utilisée pour discriminer les individus ayant évolué dans des milieux distincts tant par leurs caractéristiques physico-chimiques (Morat et al., 2008) que par la quantité et la qualité de la nourriture disponible (Gagliano et McCormick, 2004). Ainsi sur la base de la forme de l'otolithe, les individus capturés dans les cantonnements et dans les zones exploitées peuvent être discriminés.

Les résultats sont présentés sous forme de publications qui constituent des chapitres différents. Chacun de ces chapitres peut être lu indépendamment des autres. Le tableau 1 synthétise les hypothèses émises et les chapitres qui y répondent. Suite à la présente introduction (**CHAPITRE I**), le plan de la thèse est le suivant :

**CHAPITRE II :** Présentation des sites et des méthodes

Dans ce chapitre, après une présentation générale de la Martinique et des cantonnements étudiés, les méthodes d'échantillonnage et d'analyse des captures seront brièvement évoquées étant décrites en détail dans les Chapitres III et IV. Par contre les méthodes d'analyse de l'otolithe seront détaillées.

**CHAPITRE III :** Response of exploited Caribbean reef fishes to protection. (soumise à *Ecological Applications*)

**CHAPITRE IV:** Catch-length structure of reef fishes as an indicator of the protection effect in Martinique. (soumise à *Coral Reefs*)

**CHAPITRE V:** Age and growth of the Caribbean redband parrotfish *Sparisoma aurofrenatum* inside and outside a marine reserve. (en préparation)

**CHAPITRE VI:** Discrimination of Caribbean redband parrotfish (*Sparisoma aurofrenatum*) from protected and unprotected areas using otolith shape. (en préparation)

**CHAPITRE VII:** Discussion générale

**Tableau 1.** Synthèse des hypothèses avec les chapitres correspondant

	Chapitres
Captures totales et spécifiques	III
Structure de taille	III, IV
Différence de réponse des espèces à la protection	III, VI
Différence de performance des cantonnements	III
Age et croissance de <i>Sparisoma aurofrenatum</i>	V
Discrimination des individus par l'analyse de la forme de l'otolithe	VI

# **CHAPITRE II**

## **SITES ET MÉTHODES**

# SITES ET MÉTHODES

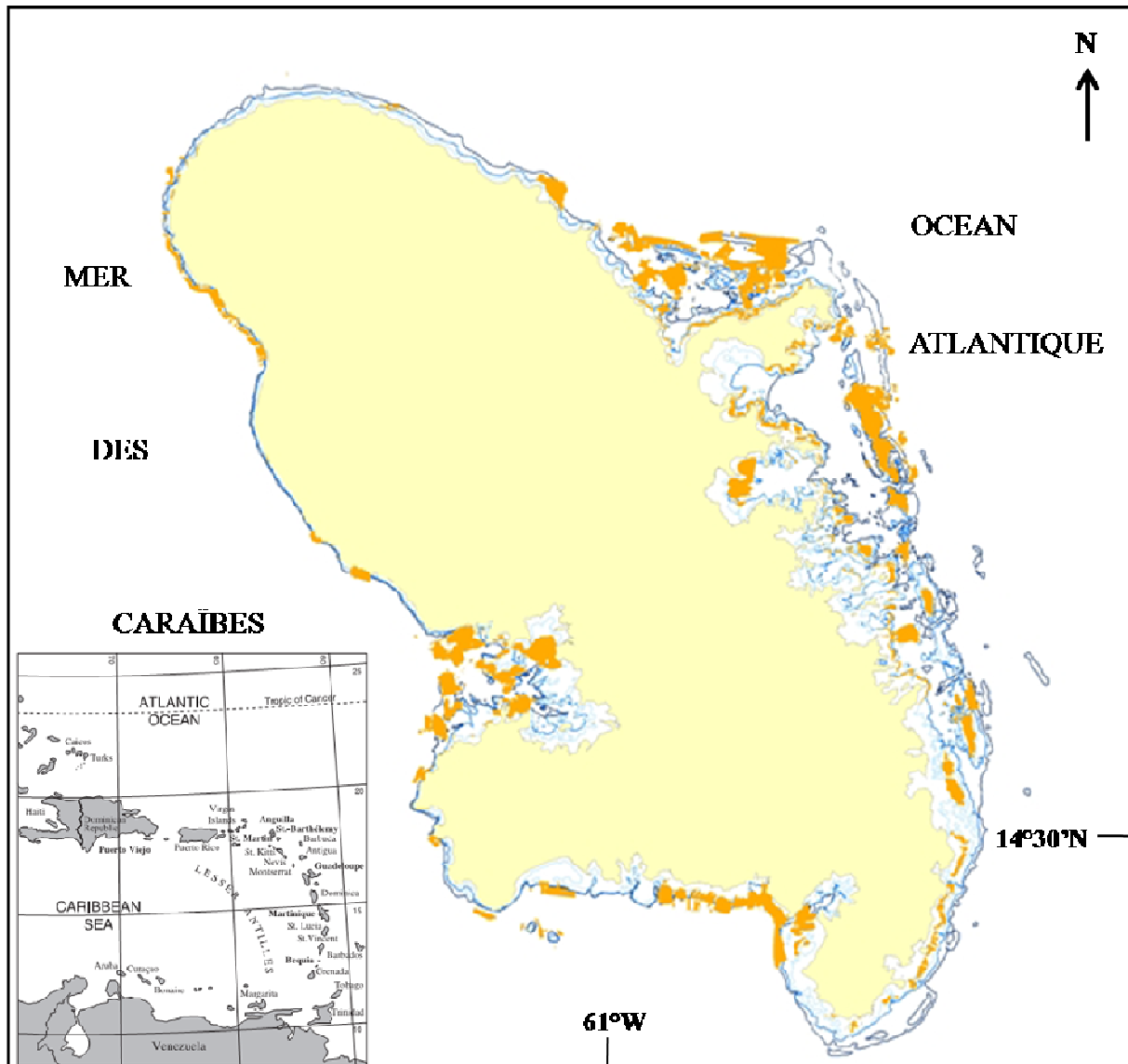
## 1. PRÉSENTATION GÉNÉRALE DE LA MARTINIQUE

### 1.1. CADRE GÉOGRAPHIQUE

D'une superficie de 1100 km<sup>2</sup>, la Martinique est située par 14°30' de latitude nord et par 61° de longitude ouest au centre des Petites Antilles entre la Dominique et Sainte-Lucie (Fig. 3). Formée au Pliocène, la Martinique est une île volcanique présentant un relief très accidenté notamment au nord où sont localisés la Montagne Pelé (1397 m), volcan encore en activité, et les Pitons du Carbet (1207 m).

Le plateau continental s'étend sur 1447,5 km<sup>2</sup> et présente une forte asymétrie. En effet, il est plus étendu sur la côte atlantique et particulièrement étroit sur la côte caraïbe. La côte est de l'île, très battue et accidentée, forme une succession de baie et de péninsules. Sa partie nord, non protégée par des récifs, est caractérisée par une bande côtière très étroites et des conditions hydrodynamiques difficiles avec de forts courants et une houle importante. La côte caraïbe, côte sous le vent, bénéficie de conditions plus clémentes.

L'île abrite les trois grandes biocénoses marines côtières de la Caraïbe, à savoir les mangroves, les herbiers de Phanérogames marines et les récifs coralliens. La majorité des mangroves se situent dans le sud de l'île dans la baie de Fort-de-France et dans les baies de la côte atlantiques. Les herbiers de Phanérogames sont constituées de deux espèces, *Thalassia testudinum* et *Syringodium filliforme*. Ils ont la même répartition que les mangroves avec lesquelles ils sont souvent associés. Les récifs sont surtout développés sur la côte atlantique où ils s'étendent sur 200 km<sup>2</sup>. Globalement, l'état de santé des biocénoses en Martinique est préoccupant puisque 43% des communautés coralliennes et 11% des herbiers sont très dégradés (OMMM, 2009).



**Figure 3.** Situation géographique de la Martinique. Les formations coralliennes sont représentées en orange (réalisée à partir d'une carte d'Hélène Legrand)

## 1.2. FACTEURS ENVIRONNEMENTAUX

### 1.2.1. Le climat

La Martinique possède un climat de type tropical où on distingue deux saisons de durée égale basées sur le régime pluviométrique. Il s'agit de la saison sèche où « carême » de novembre à mai caractérisée par une faible pluviométrie et une saison humide ou « hivernage » caractérisée par une pluviométrie élevée et le passage d'ondes, de dépressions tropicales et certaines années de cyclones.



### **1.2.2. Les vents et la houle**

Les vents dominants sont les alizés soufflant régulièrement toute l'année de secteur est. Il en résulte l'établissement d'une houle de secteur est à nord-est. Plus rarement, la côte caraïbe est soumise à une houle très puissante et dévastatrice de secteur nord-ouest résultant de l'activité cyclonique dans le Golfe du Mexique.

### **1.3. CADRE HALIEUTIQUE**

La flotte martiniquaise est composée de 1160 navires dont la majorité est inférieure à 12 m (Iborra, 2007). La flotte se répartit en deux types de pêche. D'une part, la pêche côtière et d'autre part, la pêche à « Miquelon », pratiquée au-delà des limites de visibilité de la côte pendant la saison sèche et qui exploite les grands pélagiques tels que les thons ; les marlins et les dorades coryphènes.

Les nasses représentent le principal mode d'exploitation des ressources côtières benthiques (Gobert, 1990; Guillou et Lagin, 1997) devant les lignes et les filets maillants (Iborra, 2007) et se répartissent principalement dans la strate 0-30 m de profondeur. La taille minimale légale de la maille des nasse est de 31 mm (Gobert, 1994) alors que dans la plupart des régions de la Caraïbe y compris en Guadeloupe, cette taille minimale est de 38 mm.

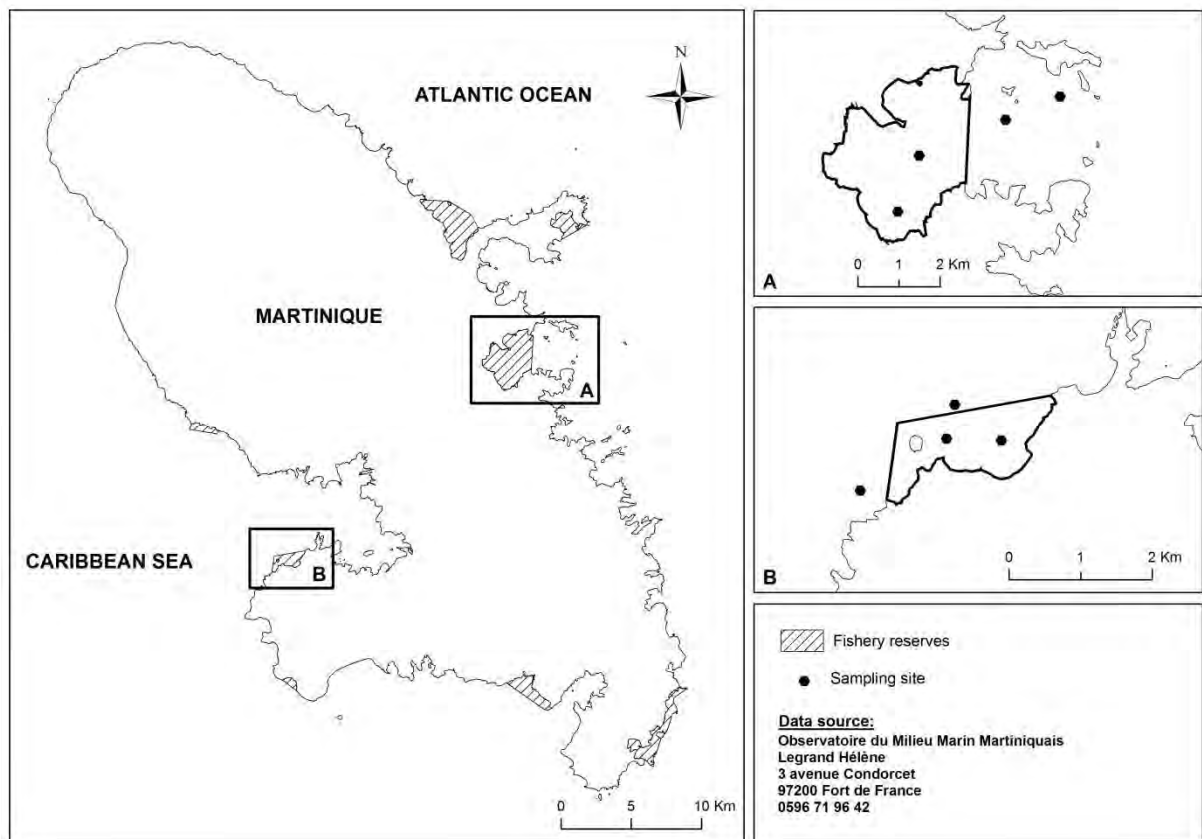
La pression de pêche élevée et la surexploitation qui en résulte ont été évoquées dans le Chapitre I. De nombreux stocks sont considérés comme étant en péril tels que l'oursin (*Tripneustes ventricosus*), le lambi (*Strombus gigas*) ainsi que des espèces de Lutjanidae et de Scaridae. Outre la création de cantonnements de pêche, une réglementation de la pêche à l'oursin, à la langouste et au lambi a été mise en place et de nombreux dispositifs de concentration de poisson (DCP) ont été installés dans le but de rediriger l'effort vers les ressources pélagiques du large afin de soulager la bande côtière.

## **2. PRÉSENTATION DES CANTONNEMENTS ÉTUDIÉS ET DES MÉTHODES**

### **2.1. CANTONNEMENTS**

Deux des huit cantonnements mis en place ont été étudiés dans le cadre de ce travail, à savoir les cantonnements de l'Ilet à Ramier et de la Baie du Robert (Fig. 4). Le choix s'est fait en fonction des attentes du Comité des Pêches et des Élevages Maritimes et de la Commission

Pêche de la Région, de l'accessibilité des sites et des différences marquées des caractéristiques des cantonnements.



**Figure 4.** Localisation des cantonnements de la Baie du Robert (A) et de l'Ilet à Ramier (B)

### 2.1.1. La Baie du Robert

Le cantonnement de la Baie du Robert, situé sur la côte atlantique (Fig. 4(A)), a été créé en 2000 et protège 983 ha. La Baie du Robert est relativement fermée et exposée plein est. Elle est néanmoins protégée de la houle océanique par le récif barrière qui longe la côte sud-est de la Martinique. La profondeur de la baie n'excède pas 20 m. 70% des fonds sont sablo-vaseux avec une tendance nette à l'envasement dans le fond de la baie, les herbiers de Phanérogammes couvrent 20% de la baie et les communautés coralliennes 10% (OMMM, 2009).

Cette zone est l'une des plus exploitée de la Martinique (Gobert et Stanisière, 1997). Iborra (2007) mentionne que 32% des pêcheurs martiniquais enrôlés vivent dans les villes entre le Vauclin et Trinité, incluant la ville du Robert.

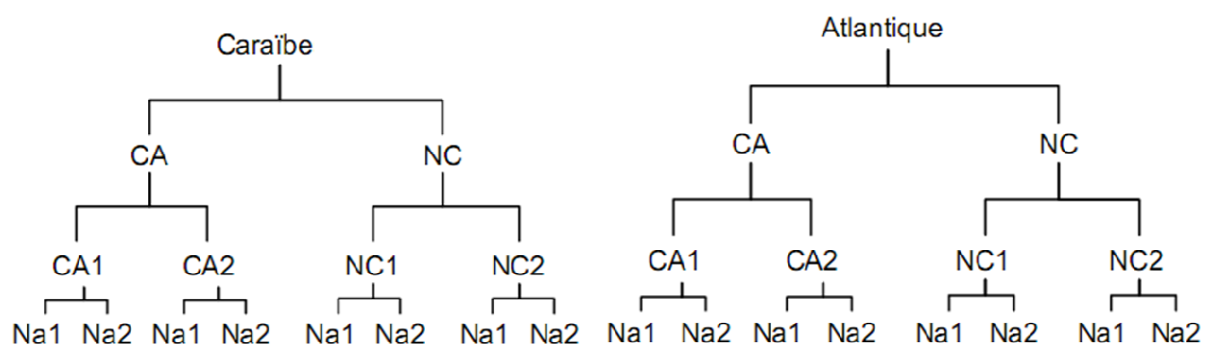
### 2.1.2. L'Ilet à Ramier

Le cantonnement de l'Ilet à Ramier est situé sur la côte caraïbe (Fig. 4(B)) et a été créé en 1999. Il protège une superficie de 184 ha. Il est localisé en limite sud de la Baie de Fort-de-France orientée plein ouest. La profondeur du cantonnement n'excède pas les 25 m et le substrat est composé à 70% de sable et à 13% de roches. Les herbiers de Phanérogammes couvrent 10% et les débris coralliens 7% (OMMM, 2009). La principale caractéristique de ce cantonnement est la présence sur ses limites nord de l'Ilet à Ramier, ilet rocheux de 40 m de haut et d'une superficie de 3 ha à côtes pentues complètement recouvert d'un important manteau arboré. C'est un terrain militaire inhabité, interdit d'accès et protégé par un arrêté de biotope pour la protection et la conservation d'une faune et d'une flore riches et spécifiques.

Tout comme la Baie du Robert, cette zone est intensivement exploitée par une communauté de pêcheurs représentant 24% des pêcheurs enrôlés de l'île (Iborra, 2007).

## 2.2. ÉCHANTILLONNAGE

L'échantillonnage a été réalisé par pêches expérimentales à la nasse avec la participation d'un pêcheur pour chaque zone. Les nasses, fabriquées sur place par un pêcheur, sont des nasses en forme de Z à deux entrées comme celles communément utilisées par les pêcheurs. Comme il a été précisé dans l'introduction, les méthodes d'échantillonnage, les mesures effectuées sur les poissons et l'analyse des données de captures ayant été exposées en détail dans les Chapitres III et IV, nous expliquons ici de manière succincte le protocole d'échantillonnage sous la forme d'un schéma (Fig. 5).

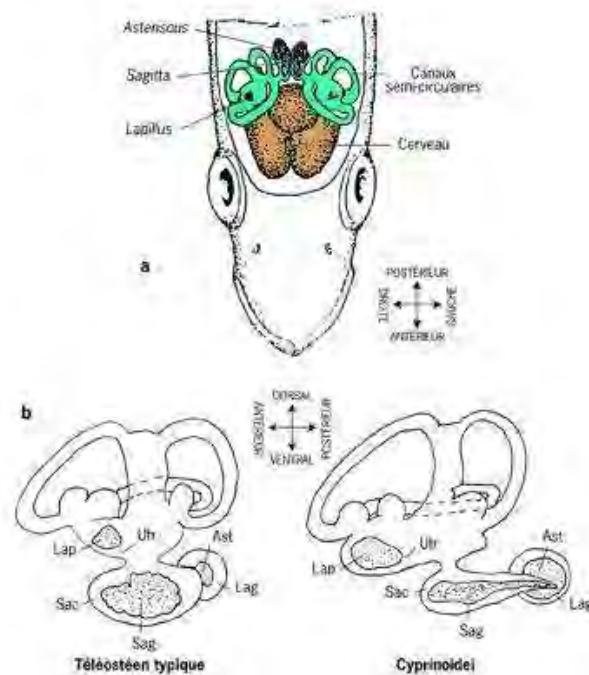


**Figure 5.** Schéma du protocole d'échantillonnage. Ce protocole est mis en œuvre pendant les deux saisons d'échantillonnage réalisées en 2007 et 2008. CA : cantonnement ; NC : zone non protégée ; Na : nasse.

## 2.3. OTOLITHES

### 2.3.1. Généralités

Les otolithes sont des pièces calcifiées présentes uniquement chez les poissons ostéichthyens. Ces poissons possèdent une oreille interne divisée en trois sacs membraneux contenant chacun une paire d'otolithes : les *sagittae*, la plus grande paires, contenues dans le *sacculle* ; les *lapilli* et les *asterisci*, plus petites, situées respectivement dans l'*utricule* et la *lagena* (Fig. 6).



**Figure 6.** Appareil vestibulaire

a) Vue dorsale de l'appareil vestibulaire

b) Les trois paires d'otolithes à l'intérieur du système labyrinthique de poisson. Sag : sagitta ; Sac : sacculle ; Lap : lapillus ; Utr : utricule ; Ast : astericus ; Lag : lagena (D'après Panfili et al., 2002)

Les otolithes sont constitués de carbonate de calcium ( $\text{CaCO}_3$ ) principalement cristallisé sous la forme d'aragonite entourée d'une matrice protéique, l'otoline (Campana, 1999). La formation de l'otolithe commence à partir du *primordium* sécrété par l'oreille interne. Le *nucleus*, qui constitue le premier anneau d'accroissement proviendrait de la fusion d'un ou plusieurs centres de calcification de l'oreille interne (Campana et Neilson, 1985).

La croissance de l'otolithe se fait par juxtaposition journalière de couches concentriques de carbonates et d'otoline. Ce phénomène aboutit à la formation de zonations composées de deux parties : une zone d'accrétion large et calcifiée caractérisée par une forte concentration

en cristaux de carbonates de calcium et une zone de discontinuité étroite et organique composée de fibres épaisses d'otoline (Campana et Neilson, 1985). Ces marques de croissance sont utilisées pour lire déterminer l'âge des poissons.

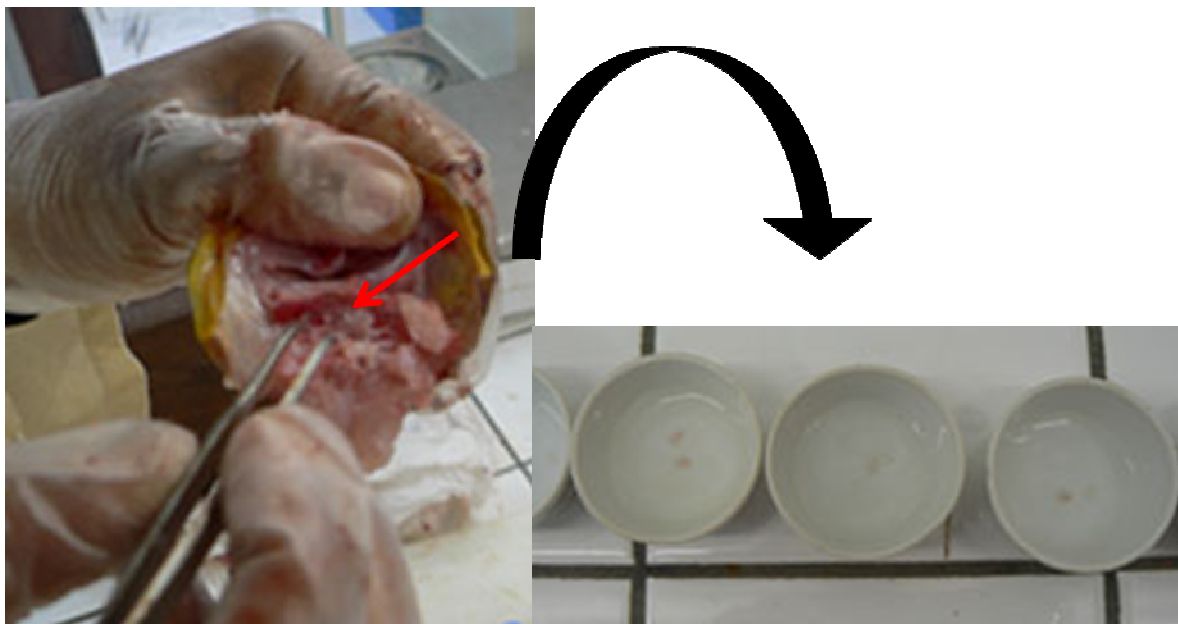
Les otolithes jouent un rôle important dans les fonctions de maintien de l'équilibre et d'orientation du poisson.

Les otolithes sont des enregistreurs naturels de données de variations de croissances et de changements d'habitats, et inscrivent les informations dans leur microstructure et leur chimie. Ces informations telles que l'âge, la croissance, les migrations, la reproduction ou le stress sont fondamentales pour la gestion des pêcheries (Begg et al., 2005a).

Dans le cadre de ce travail, nous utiliserons l'otolithométrie qui est l'estimation de l'âge à partir de l'otolithe et la morphologie de l'otolithe.

### 2.3.2. Extraction

Les *sagittae* d'Acanthuridae, de Scaridae, de Lutjanidae, d'Haemulidae et de Serranidae ont été extraites à l'aide de pinces fines, nettoyées à l'eau distillée afin d'ôter les tissus d'endolymphe (Fig. 7) et séchées délicatement sur du papier absorbant (Panfili et al., 2002). Chaque paire a été ensuite conservée à sec dans des tubes étiquetés avec les initiales de l'espèce, le numéro de l'individu, un code cantonnement/zone exploitée et le site.



**Figure 7.** Extraction des *sagittae* (du Labridae *Bodianus rufus*) et leur transfert dans des coupelles contenant de l'eau distillée

### 2.3.3. Morphologie des otolithes

La forme des otolithes est spécifique des espèces de poissons (L'Abée-Lund, 1988; Campana et Casselman, 1993). Cependant des variations intra-spécifiques existent en fonction de la taille des poissons, de l'habitat ou encore de la qualité et la quantité de nourriture disponible (Tuset et al., 2003b; Gagliano et McCormick, 2004).

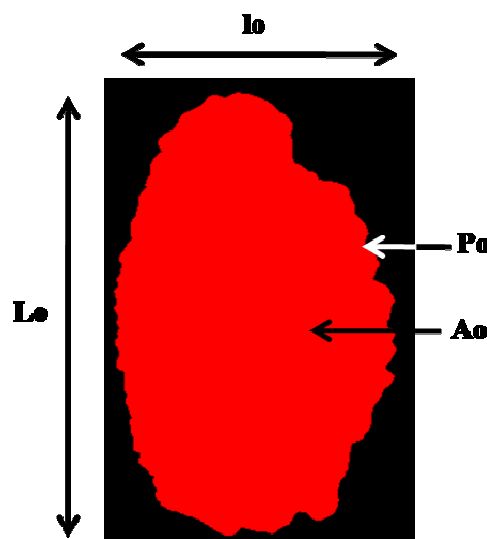
#### 2.3.3.1. Numérisation des *sagittae*

Chaque otolithe, placé à plat *sulcus* vers le haut, est numérisé à l'aide d'une loupe binoculaire (Leica MZ16) munie d'une caméra vidéo (Médiacynernetic evolution LS color) reliée à un PC. L'acquisition et le traitement des images sont effectuées à l'aide du logiciel Visilog 6.2 (Société Noesis). L'intensité et la direction de la lumière sont réglées grâce à un éclairage épiscopique sur fibres optiques. Les photos sont réalisées en lumière surexposée puis binarisées de façon à uniformiser l'image.

#### 2.3.3.2. Descripteurs de distance et indices de forme

A partir de l'image binarisée, le logiciel calcule les descripteurs de distance (Fig. 8) :

- $L_o$  : longueur maximale
- $l_o$  : largeur maximale
- $P_o$  : périmètre
- $A_o$  : surface projetée



**Figure 8.** Descripteurs de distance mesurés sur l'image binarisée d'une *sagittae*

Les indices de forme sont calculés à partir des descripteurs de distance combinés de manières différentes (Tableau 2).

**Tableau 2.** Indices de forme (facteur de forme, rondeur, circularité, rectangularité et ellipticité)

Shape indice	Formula
Form factor	$(4\pi A_0)/P_0^2$
Roundness	$(4A_0)/(\pi L_0^2)$
Circularity	$P_0^2/A_0$
Rectangularity	$A_0/(L_0 \times b)$
Ellipticity	$(L_0 - b)/(L_0 + b)$

Ces indices estiment respectivement l'irrégularité de l'aire, donnent des informations sur la similarité des différentes caractéristiques du cercle parfait, décrivent les variations de la longueur et de la largeur par rapport à l'aire et indiquent les changements dans l'axe proportionnels.

### 2.3.3.3. Analyse du contour de la *sagittae* : analyse de Fourier elliptique

Les mesures morphométriques décrites ci-dessus ont été complétées par une analyse de contour faite à l'aide d'un modèle mathématique.

La forme d'un objet peut-être décrite à divers degrés de précision en utilisant la décomposition de son contour par les transformées de Fourier. Dans cette méthode, le contour est fonction périodique qui s'exprime en somme de termes d'une série trigonométrique à base de sinus et de cosinus. Cette série est caractérisée par des composés appelés harmoniques dont les coefficients peuvent servir de variables descriptives pour la forme de l'objet. L'expression du contour à l'aide d'une fonction mathématique nécessite la détermination de coordonnées des points situés sur le contour entier de l'objet. Le jeu des coordonnées permet d'obtenir par transformées de Fourier, les coefficients de Fourier qui serviront en tant que variables descriptives dans une analyse multivariée.

La transformée de Fourier elliptique repose sur le principe que le contour fermé d'un objet peut être représenté par deux séries  $x(t)$  et  $y(t)$  correspondant aux projections du contour respectivement sur l'axe des abscisses et l'axe des ordonnées d'un repère quelconque. Les projections seront fonction de la distance ( $t$ ) mesurée le long du contour, à partir d'un point

arbitraire. Ainsi, pour la projection sur les deux axes de la série  $x(t)$  et  $y(t)$ , la transformée de Fourier se formule comme suit (Kuhl et Giardina, 1982) :

$$x(t) = (A_0/2) + \sum_{n=1}^N (A_n \cos n \omega t + B_n \sin \omega t)$$

$$y(t) = (C_0/2) + \sum_{n=1}^N (C_n \cos n \omega t + D_n \sin \omega t)$$

- $A_n, B_n, C_n, D_n$  : coefficients de Fourier à la  $n^{\text{ième}}$  harmonique
- $\omega : 2\pi/t$
- $t$  : distance de l'arc mesuré le long du contour à partir d'un point de départ arbitraire.  $t \in [0, T]$ ,  $T$  étant le périmètre du contour fermé.  $T$  est aussi la période
- $n$  : nombre d'harmoniques
- $N$  : nombre total d'harmoniques utilisés pour approcher  $X(t)$

Pour la fonction  $x(t)$  correspondant à la projection du contour sur l'axe des abscisses, on calcule les deux coefficients de Fourier  $A_n$  et  $B_n$  :

$$A_n = \left( \frac{T}{2n^2\pi^2} \right) \sum_{p=1}^k \frac{\Delta x_p}{\Delta t_p} \times \left( \cos \frac{2n\pi t_p}{T} - \cos \frac{2n\pi t_{p-1}}{T} \right)$$

$$B_n = \left( \frac{T}{2n^2\pi^2} \right) \sum_{p=1}^k \frac{\Delta x_p}{\Delta t_p} \times \left( \sin \frac{2n\pi t_p}{T} - \sin \frac{2n\pi t_{p-1}}{T} \right)$$

- $k$  : nombre de points du contour (indexé par  $p$ )
- $\Delta x_p$  : déplacement sur l'axe des abscisses du contour entre les points  $p-1$  et  $p$
- $\Delta t_p$  : longueur du segment linéaire compris entre les points  $p-1$  et  $p$
- $t_p$  : somme cumulée des longueurs de segments  $\Delta t_p$

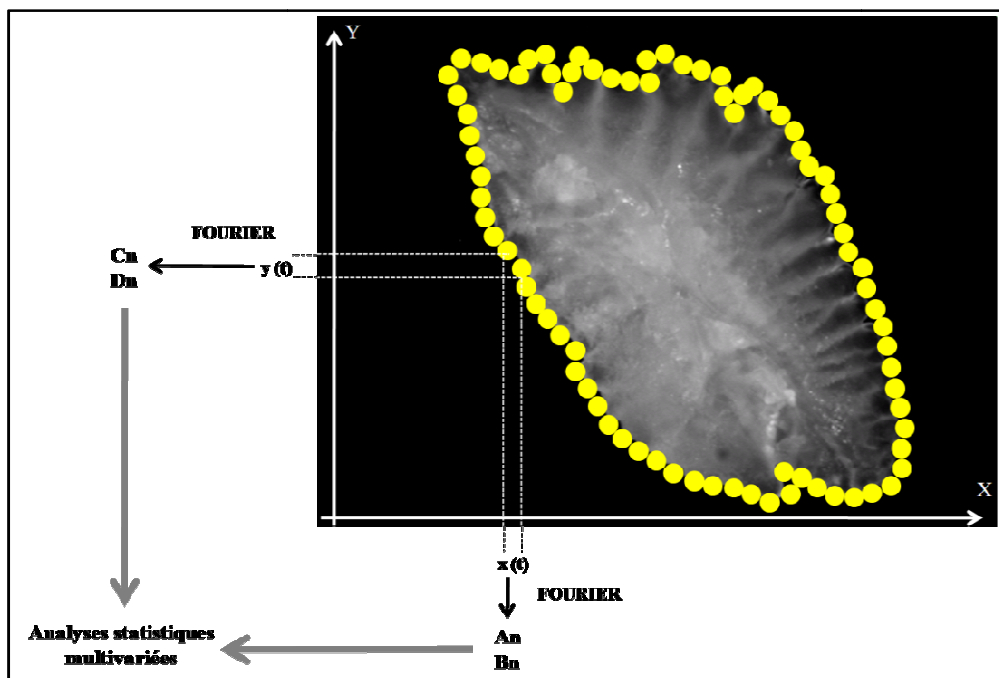
Les coefficients  $C_n$  et  $D_n$  sont calculés de la même façon pour la fonction  $y(t)$  correspondant à la projection du contour sur l'axe des ordonnées. La transformée de Fourier permet donc de calculer à partir d'un contour fermé à  $k$  points, 4 coefficients par harmoniques ( $A_n$  et  $B_n$  pour l'axe des abscisses, et  $C_n$  et  $D_n$  pour l'axe des ordonnées). Le principe de la transformée de Fourier est résumé par la Figure 9.

En suivant la procédure inverse de celle utilisée pour calculer les coefficients  $A_n, B_n, C_n$  et  $D_n$  de Fourier, il est possible de recalculer les  $k$  coordonnées des  $k$  points d'un contour à partir de ces coefficients. C'est la transformée inverse de Fourier. C'est une propriété intéressante de l'analyse de Fourier qui permet de contrôler, pour un nombre d'harmoniques



donné, la qualité de l'approximation du contour réel par le contour calculé. Giardina et Kuhl (1997) ont montré qu'à chaque harmonique, les points recalculés par transformée inverse décrivaient une ellipse. La reconstruction du contour par les harmoniques d'ordre croissant peut ainsi être visualisé comme étant le déplacement net d'un point autour d'une superposition d'ellipses, orthogonales et de plus en plus petites.

La qualité de reconstruction d'un contour peut être jugée grâce au contour redessiné par l'analyse inverse de Fourier. Cette méthode visuelle peut être complétée par la « puissance de Fourier » (Crampton, 1995). Ce calcul simple permet de déterminer le nombre d'harmoniques nécessaires pour approcher le plus fidèlement possible le contour originel de la *sagitta*. A l'aide d'un graphique, il devient possible de détecter l'harmonique à partir de laquelle 99,99% de la puissance totale est atteinte, l'écart-type de la puissance totale étant minimum.



**Figure 9.** Schématisation des résultats attendus par l'utilisation de la transformée de Fourier sur un contour fermé à k points.

Le calcul de la puissance de Fourier à la  $n^{\text{ième}}$  harmonique ( $PF_n$ ) s'effectue comme suit :

$$\text{-----}$$

où  $A_n$ ,  $B_n$ ,  $C_n$  et  $D_n$  sont les coefficients de Fourier elliptique calculés à la  $n^{\text{ième}}$  harmonique.

Pour déterminer le nombre d'harmoniques nécessaire pour décrire les *sagittae* des poissons capturés dans le cadre de ce travail, la puissance de Fourier a été appliquée à un sous

échantillon aléatoire de 20 *sagittae* en fixant par le nombre d'harmoniques à 30. La puissance de Fourier cumulée moyenne a ensuite été représentée en fonction du nombre d'harmoniques. Le seuil de 99,99% de la puissance totale a été choisi pour déterminer le nombre d'harmoniques nécessaire. Le reste de l'échantillon a été ensuite traité en utilisant le nombre d'harmoniques déterminé pour le sous échantillon. La détermination du nombre d'harmoniques et la détermination des coefficients de Fourier est faite grâce au logiciel SHAPE 1.3.

Les coefficients de Fourier sont utilisés comme descripteurs de la forme dans les analyses multivariées. Au préalable, les coefficients  $A_0$  et  $C_0$  (coordonnées du barycentre des *sagittae* donc n'apportant aucune information) et ceux de la première harmonique ( $A_1$ ,  $B_1$ ,  $C_1$  et  $D_1$ ) qui n'est qu'une simple ellipse contribuant très peu à la définition du contour. Les analyses multivariées utilisées pour différencier ou pas nos individus provenant des cantonnements et des zones adjacentes exploitées et pêchées à deux saisons distincts sont des analyses discriminantes à l'aide du logiciel SPSS 16.0. Les analyses discriminantes font parties des méthodes d'ordination en espace réduit. L'analyse discriminante sépare des groupes connus d'objets (chaque individu est assigné à un groupe ; dans notre cas cantonnement/zone pêchée ou côte atlantique/côte caraïbe) en maximisant les différences inter-groupe tout en minimisant les différences intra-groupe. La qualité de la discrimination se mesure par la valeur du lambda de Wilks qui est le rapport entre la variance intra-groupe et la variance inter-groupe (ou totale). De ce fait, la discrimination entre les groupes est meilleure lorsque la variance totale est grande alors que la variance intra-groupe est la plus faible possible. Le lambda de Wilks est compris entre 0 (maximum de discrimination) et 1 (pas de discrimination entre les groupes).

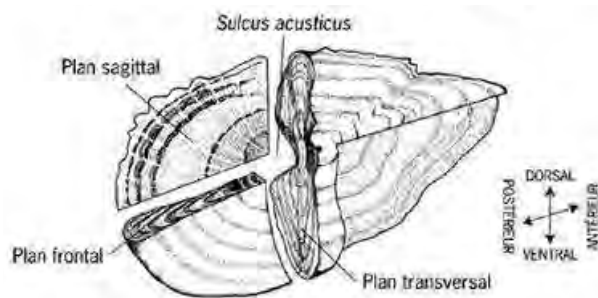
#### **2.3.4. Otolithométrie**

L'otolithe est utilisée en temps qu'indicateur de l'âge des poissons depuis très longtemps (Begg et al., 2005a). Dans ses travaux, Pothin (2005) indique une utilisation au cours des XVIII<sup>ième</sup> et le XIX<sup>ième</sup> siècle.

##### **2.3.4.1. Préparation des lames minces**

Au préalable, les otolithes ont été pesés à l'aide d'une balance de précision au  $10^{-5}$  g près. L'otolithe droit de chaque paire a été choisi, la gauche n'étant utilisé qu'en cas de perte ou de cassage lors des différentes étapes de la préparation des lames. Les *sagittae* ont été

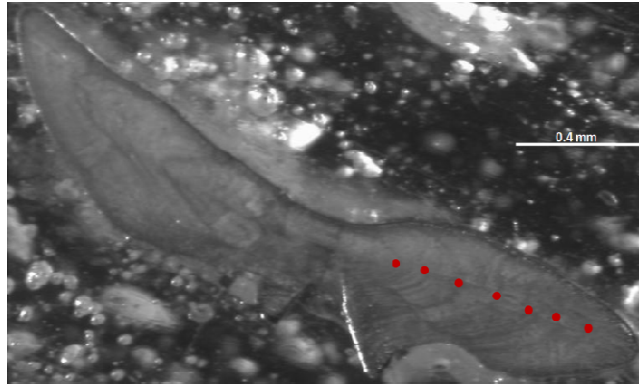
poncées suivant un plan de coupe transversal (Fig.10). Le plan de coupe doit passer par le nucleus afin de ne perdre aucune information



**Figure 10.** Les trois plans classiques de section des *sagittae* (Panfili et al., 2002)

L'otolithe est monté et fixé sur une lame à l'aide d'un polymère thermoplastique, le Crystal Bond<sup>TM</sup>. La lame est d'abord posée quelques secondes sur une plaque chauffante de façon à faire fondre le polymère. Puis la *sagittae* est posée à plat, *sulcus* vers le haut, de manière à ce que la partie rostrale dépasse le bord de la lame, le *nucleus* devant approcher le bord de la lame sans toutefois le dépasser. La lame est durcit à l'eau distillée puis la partie rostrale est éliminée sur du papier abrasif 1200 puis 2400 (grains/cm<sup>2</sup>), toujours en rinçant la lame à l'eau distillée à chaque changement de grain de papier abrasif de façon à éliminer les traces de ponçage. La lame est à nouveau chauffée de façon à déplacer l'otolithe vers le centre de la lame face poncée contre la lame. La partie distale de l'otolithe est ainsi poncée aux papiers abrasifs 1200 puis 2400, puis avec des disques de ponçage de 9, 3 et 1  $\mu$  afin de se rapprocher du nucleus et finalement avec un disque de ponçage de 0,3  $\mu$  pour éliminer les traces de ponçage.

La lame obtenue (Fig. 11) est observée sous loupe binoculaire et étiquetées si le résultat est satisfaisant. Dans le cas contraire la lame est poncée à nouveau sur les disques de ponçage à grains les plus fins.



**Figure 11.** Lame mince obtenue après ponçage d'un otolithe de *Sparisoma aurofrenatum*.

### 2.3.4.2. Age et croissance

La détermination de l'âge et l'étude de la croissance des poissons sont basées sur le dénombrement des marques de croissance. Il est donc nécessaire de valider la chronologie exacte de la croissance de l'otolithe. Dans le cas des espèces étudiées au cours de ce travail, de précédentes études ont validé la chronologie des marques de croissance (Amilhat, 1999; Luckhurst et al., 2000; Choat et al., 2003), nous permettant de nous affranchir de cette étape.

Chaque lame est lue par trois lecteurs différents. Une relecture est faite dans les cas de désaccords importants qui, s'ils persistent, aboutissent à la mise à l'écart de la lame.

Les données de taille en fonction de l'âge sont utilisées pour établir la courbe de croissance des espèces avec le modèle de Von Bertalanffy :

$$L_t = L_\infty \times (1 - \exp^{-K(t-t_0)})$$

- $L_t$  est la longueur moyenne à l'âge  $t$
- $L_\infty$  est la longueur asymptotique moyenne ou longueur maximale observée dans les captures étudiées
- $K$  est le coefficient de croissance de Brody.  $K$  est lié à la courbure de la trajectoire de croissance ainsi, des valeurs de  $K$  élevées indiquent des changements plus rapides du taux de croissance
- $t_0$  est l'âge initial où la longueur théorique est 0

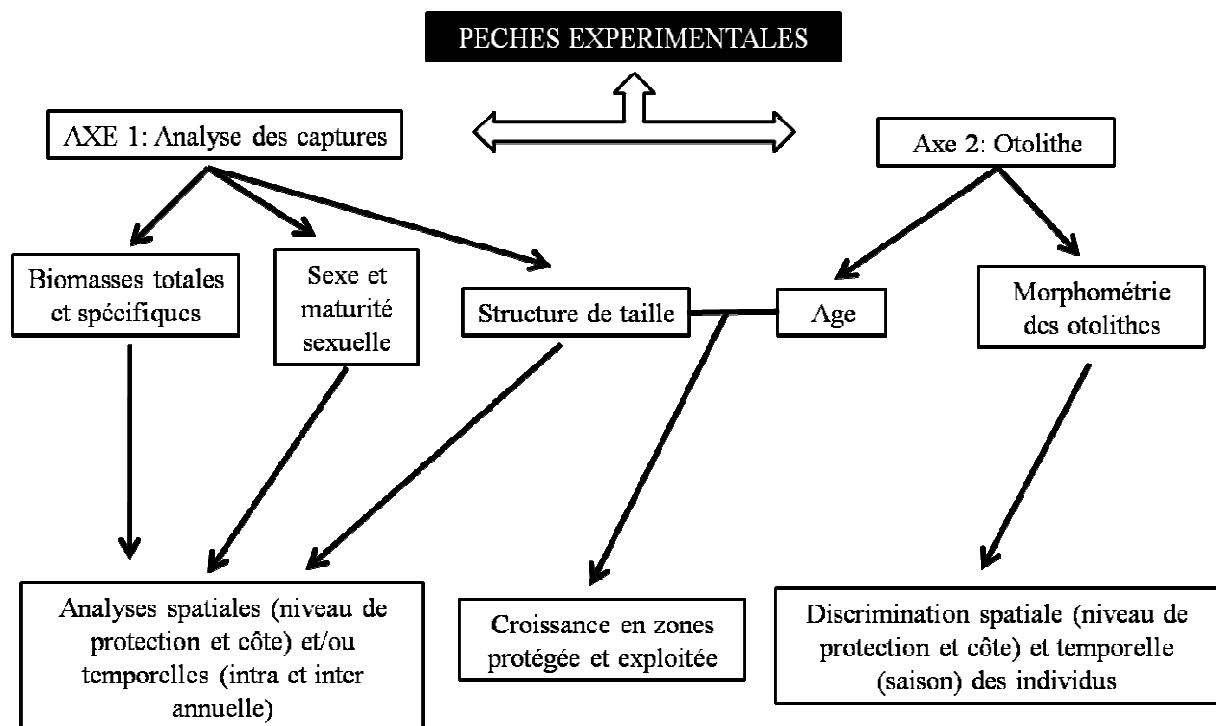
En complément, la condition est évaluée par l'indice morphométrique de condition ou coefficient de condition de Fulton  $K$  :

$$K = P/L^3$$

- $P$  est le poids en gramme
- $L$  est la taille en cm

Le facteur de condition est un indicateur de l'état physiologique du poisson. Cela indique que pour une taille donnée, un poisson plus lourd évolue dans de meilleures conditions environnementales. C'est un indice qui donne rapidement une indication sur le « bien-être » du poisson (Lambert et Dutil, 1997).

Les différentes méthodes et analyses utilisées au cours de ce travail qui vise à évaluer les effets de la protection sur les espèces exploitées et qui s'articule autour de deux axes sont schématisées dans la Figure 12.



**Figure 12.** Schéma récapitulatif des différentes méthodes et analyses réalisées au cours de ce travail pour évaluer l'effet de la protection sur les communautés de poissons exploités

## **CHAPITRE III**

# **Response of exploited Caribbean reef fishes to protection**

Response of exploited Caribbean reef fishes to protection

Géraldine CRIQUET<sup>a</sup>, Jessica GARCIA<sup>a</sup>, Jean-Philippe MARÉCHAL<sup>b</sup>, Lionel REYNAL<sup>c</sup>  
and Philippe LENFANT<sup>a</sup>

<sup>a</sup>UMR 5244 CNRS-EPHE-UPVD Center of Tropical and Mediterranean Biology and Ecology, 52 Avenue Paul Alduy Perpignan University 66860 Perpignan Cedex France

<sup>b</sup>Marine Environment Observatory of Martinique, 3 Avenue Condorcet 97200 Fort-de-France Martinique

<sup>c</sup>IFREMER Robert Station Pointe Fort 97231 Le Robert Martinique

Correspondence: Géraldine Criquet, UMR 5244 CNRS-EPHE-UPVD Center of Tropical and Mediterranean Biology and Ecology, 52 Avenue Paul Alduy Perpignan University 66860 Perpignan Cedex France

Tél: +33 4 68 66 20 55; Fax: +33 4 68 36 86

E-mail : [geraldine.criquet@univ-perp.fr](mailto:geraldine.criquet@univ-perp.fr)

(Publication submitted to *Ecological Applications*)

## Abstract

Marine reserves are increasingly considered as an efficient instrument for resource protection and fisheries management. In this paper, we evaluate the effects of two fishery reserves on Caribbean exploited reef fish assemblages. A two-year survey was conducted using experimental traps in Martinique. Multivariate analysis of variance and multivariate regression trees were used to examine target species response to protection, reserves performance and to evaluate catches changes over time inside and outside both marine reserves. Higher total catches were obtained inside both reserves and some species responded stronger to protection, especially herbivorous species, large body-size fishes and sedentary species. The effects of protection varied between the reserves according to the species group. The temporal variability of experimental catches inside and outside the fishery reserves showed that protected areas have endured better natural catastrophes impacts. This study provides encouraging results on the use of fishery reserves for protecting resources. We have also highlight that the success of fishery reserves in sustaining coastal small-scale fisheries depends on a regulation of the fishing effort in the surrounding fishing zones and a better cooperation between fishermen communities and scientists.

## Keywords:

Caribbean, Fisheries management, Hurricane impact, Marine reserves, Reef fishes, Trap fishing



## Introduction

Small-scale fisheries provide food fish for local populations and represent one of the most important economical activities in countries of the inter-tropical belt. It is clear that overexploitation occurred worldwide in coastal marine ecosystems over a long period of time, inducing deep ecological changes (Jackson et al., 2001). Many studies highlight that high fishing pressure has negative effects on the structure of fish communities including the decrease of abundances and diversity of target species (Russ et Alcala, 1989; Jennings et al., 1995), changes in the size composition (Bianchi et al., 2000; Graham et al., 2005) and in the trophic structure of communities (Friedlander et DeMartini, 2002; Dulvy et al., 2004a; DeMartini et al., 2008). Hsieh et al. (2008) have also suggested that exploited fishes could be more vulnerable to climate variability as temperature rises induce distribution shifts in exploited fishes (Perry et al., 2005). In the Caribbean, most target fishes are seriously overexploited. Intensive artisanal fishing has induced shifts in the structure of target fish assemblages (Koslow et al., 1988; Hawkins et Roberts, 2003, 2004) and benthic communities because of the reduction of herbivorous species populations and thus grazing activity (Hughes et al., 2003; Mumby et al., 2006) along with other anthropogenic and natural factors.

Confronted by the growing uncertainty of traditional management tools to reduce overexploitation and sustain fisheries (Pauly et al., 2002), marine reserves are increasingly advocated as a tool for resource protection and fisheries management (Roberts et al., 2001; Halpern et Warner, 2002). Marine reserves reduce fishing zones and prevent a part of the fish stocks from exploitation. Numerous studies have demonstrated the effects of protection. In most cases higher density, biomass and mean size of fishes are observed within the protected areas (Roberts, 1995; Wantiez et al., 1997; Chiappone et al., 2000; Graham et al., 2003; Ferraris et al., 2005; Floeter et al., 2006; Barrett et al., 2007; Francini-Filho et Moura, 2008b). However, there is limited clear evidence that MPAs induce benefits for fisheries in

surrounding areas through spillover (McClanahan et Kaunda - Arara, 1996; Russ et al., 2003; Abesamis et al., 2006; Goñi et al., 2008; White et al., 2008). Responses to protection also differed according to the behavior, the life history and the level of exploitation of species (Gerber et al., 2002; Ashworth et Ormond, 2005; Micheli et Halpern, 2005). In general, larger body-size fishes with a high level of exploitation have stronger positive responses to protection (Mosqueira et al., 2000) while non-target species may not respond, or respond negatively to protection in relation to greater predation within the protected areas (McClanahan et al., 1999). In addition, in some cases, target species do not respond to protection (Chapman et Kramer, 1999; Parnell et al., 2005) indicating that established measures are not sufficient to protect species from fishing pressure and other factors such as environmental factors which interfere with protection. The effects of protection on the genetic structure of fish populations have scarcely been investigated. It was suggested that marine reserves preserve gene pool and genetic diversity (Pérez-Ruzafa et al., 2006), but Lenfant (2003) found a similar genetic structure between fishes inside and outside a Mediterranean marine reserve.

In Martinique, the local Authorities, faced to an alarming decline of the coastal fisheries, have decided to establish a network of fishery reserves around the island in order to sustain fishing activities by protecting spawning, reproduction sites and adult populations. Unfortunately, little information is available on catches composition and impacts of exploitation of adjacent fishing zones except that most of coastal stocks are overexploited (Gobert, 1992, 2000). Moreover, 10 years after the implementation of the first fishery reserve, no study has yet been conducted to investigate the effects of protection. It is thus more difficult to emphasize the reserve effects that could be confounded with temporal and spatial variability of the fish communities. For example, Kulbicki et al. (2007) found that time was the most influential factor on fish assemblages at the Aboré barrier reef Reserve, New-

Caledonia. In the same way, habitat characteristics often have a significant effect on the structure of fish assemblages suggesting that the habitat effects (habitat differences within and outside the reserve) need to be separate from those of protection (Willis et Anderson, 2003; García-Charton et al., 2004; Harborne et al., 2008). According to Fraschetti et al. (2002), the most appropriate sampling design to separate natural variations from protection effects consist in a “BACI” (Before After Control Impact) design with multiple control sites with similar habitats to those of the protected area. In our case, like in many reserve effects studies, we compare protected and unprotected areas after the reserve establishment, “ACI” After Control Impact (Glasby, 1997). In this case, the choice of the control sites in the unprotected area is crucial.

Assessing the impact of marine reserves is necessary if not obligatory in order to evaluate if establishment objectives were achieved. Most studies have used underwater visual census (UVC), while few have employed experimental fishing, data from fisheries yields or underwater video. UVC counts target fishes potentially catchable, but not always caught by fishermen. In contrast, experimental fishing samples a component of the fish assemblages that could be underestimated or undetected by UVC, like nocturnal species or species that are difficult to see because of camouflage. Furthermore, it is important to examine protection effects on target fishes by implementing sampling techniques trusted and used by fishermen (Seytre et Francour, 2008).

In this paper, we evaluated the effects of two fishery reserves on the exploited fish assemblages using experimental fishing. Differences in responses to protection of the target species were examined. We investigated protection effects variation among reserves to see if reserves performed differently. We propose a survey over two years to evaluate whether or not protection effects evolve over time.

## Methods

### *Study sites*

We focused on Ilet à Ramier (IR) and Baie du Robert (BR) fishery reserves, located on the Caribbean Sea and Atlantic Ocean coasts of Martinique, respectively (Fig. 1). The reserves are ecologically different, especially the size and habitat characteristics (Table 1). In both cases, the surrounding fishing zones are characterized by a strong fishing effort of nearly 2500 traps.km<sup>-2</sup> (Gobert et Stanisière, 1997). We selected these reserves according to their location, their accessibility, and the possibility of working with local fishermen and the Local Fisheries Office.

### *Sampling design and data collection*

Unbaited double funnel Antillean-Z traps (2x0.6x0.3 m mesh-sized of 31 mm) were used for the experimental fishing campaigns. Traps are the most common fishing gear used in the Caribbean Region (Gobert, 1998) and produce approximately 70% of the benthic catches in Martinique (Gobert, 1990). Traps fishing campaigns were conducted simultaneously at the two locations during the dry (March and April) and the wet (September and October) seasons in 2007 and 2008 to detect variability at different temporal scales. Each fishing event consisted of 2 sites within the fishery reserves (FRs) and 2 sites in the surrounding fishing zones (FZs) with 2 traps per site (Fig. 1). Traps were set during 5 days at same depth and on similar habitats in FR and FZ at each location. Sites were not permanent: after each fishing event, the traps were moved to other sites. No commercial value fishes were released at their capture site after having been weighted in (g) and measured (cm). Commercial value fishes were brought to the laboratory where total length (cm) and wet weight (g) were recorded, and also for sexual identification and otoliths removal.

Unexpectedly, the Local Fisheries Office decided to open the Ilet à Ramier reserve to fishing from May to November 2007. We decided nevertheless to sample the 2007 wet season in spite of the protection status removal, as planned in our protocol (see above). In addition, environmental disturbances occurred during the two years of the sampling affecting more or less the Caribbean and Atlantic coasts. These events are recapitulated in Fig. 2.

### *Data analysis*

Fishes were classified into taxonomic, trophic, mobility, fish size and fishing value categories (see Appendix). The information was derived from FISHBASE (Pauly et Froese, 1991) and from the fish markets of Martinique. Four size classes were used: Small (fish less than 15 cm), Medium (16 to 20 cm), Large (21 to 25 cm) and XLarge (fish larger than 25 cm). Regarding the group of mobility, sedentary species included species with restricted horizontal and vertical movements and a strong site attachment; mobile species included species that often have a large home range and that can travel long distances for foraging and reproduction. We excluded no commercial and no trap target species from analyses. Regarding trophic groups and families, Acanthuridae, Scaridae, Lutjanidae, Haemulidae, macrocarnivorous, microcarnivorous and herbivorous species were retained as other groups have negligible catches. Before we analyzed the effects of protection, we performed inter-sites comparisons for each fishing event, for both FRs and FZs using pair-wise t-test to test for significant differences in catches due to site characteristics although precautions were taken to set experimental traps on similar habitats. No differences were found between sites ( $p > 0.05$ ) except for two fishing events on the Caribbean coast at two different sampling periods. We have considered that these results were negligible in relation to the total number of fishing events and, therefore subsequent analyzes of protection effects were performed.

In a first step, we explored the relationships between each species group and Protection (FR vs FZ), Location (Caribbean vs Atlantic), Year (2007 vs 2008) and Season (dry vs wet) as factors. This preliminary analysis of the data was performed using Multivariate Regression Trees (MRT) (De' ath, 2002). This technique allows determining which of the factors most affected the target fish assemblages in order to hierarchically organize factors effects on response variables. Families, fishing value species and fishes size class that characterized each terminal leaf from the trees were identified using the indicator species index (IndVal) (Dufrêne et Legendre, 1997). This index combines the relative abundance of a species or a species group (denoting the specificity) with its relative frequency of occurrence (denoting the fidelity).

In a second step, we analyzed the total catches and defined species group catches using four-way ANOVAs with Protection, Location, Year, and Season as fixed factors. Prior to analysis, data were examined for normality using Kolmogorov and Smirnov's test. The Levene's test was used to test homogeneity of variances. A Log (x+1) transformation was performed when necessary. The interactions of factors provide an estimate of the influence of one given factor on the response variable to another given factor, we therefore talk about synergisms or antagonisms between effects of factors (Underwood, 1981). We have given a particular attention into interaction terms Protection x Location, Protection x Year and Protection x Season. If these interactions are statistically significant, it indicates synergism i.e. divergences in response to protection over time and between locations.

In a last step, we looked at the differences of the biological responses to protection across time by comparing inside and outside FRs for each sampling period using one-way ANOVA. We have also compared the catches inside the FRs between seasons and years using repeated-measures ANOVA. The same analyzes were ran for FZs.

To facilitate the interpretation of the ANOVAs results, we illustrated the total catches and the species group catches inside and outside protected areas for each location, year and season with boxplots.

## Results

A total of 55 species belonging to 18 families were caught of which 13 no commercial species and 7 commercial but no traps target species (see Appendix).

MRT were performed for catches of each species group using Protection, Location, Year and Season as explanatory factors. As all MRT were similar, only one is presented for more concision (Fig. 3). In all cases, the five-leaf tree was selected to have the smallest estimated predictive error. Trees explained 31%, 34%, 35%, 33%, and 38% of the variation in families, trophic groups, mobility groups, size classes and fishing value groups catches, respectively. The first split separated catches inside the FR from catches outside the FR. Within the FR side of the trees, the second split separated the Caribbean coast from the Atlantic coast. The latter splits, either the Caribbean or the Atlantic coast, separated 2007 from 2008. We have focused on species with an indicator index from moderate to high (between 20% and 50%). Scaridae, medium and large fishes, and species with high fishing value were indicator species of IR FR in 2007 whereas Scaridae, medium fishes and species with high fishing value were indicator species of IR FR in 2008. Acanthuridae, small fishes and species with low fishing value were specific to BR FR in 2007. Acanthuridae, medium fishes and species with low and high fishing value were specific to BR FR in 2008. These results are consistent with Fig. 4(B, C, K, L, M, O, Q).

Results of the four-way ANOVAs are given in Table 2. In all cases, Protection was significant and the catches of species were always higher inside FRs (Fig. 4) except for Haemulidae and microcarnivororous fishes that showed greater catches outside IR FR (Fig. 4(E,

G)). Total catches were also higher inside protected areas than outside (Fig. 4(A)). The Location factor was significant for Haemulidae, microcarnivorous, sedentary, small and medium fishes (Table 2). In fact, the catches of Hamulidae and microcarnivorous species were higher on the Caribbean coast (Fig. 4(E, G)). Fig. 4(I) shows that sedentary species catches were higher on the Atlantic coast. Small fishes were specific of Atlantic coast (Fig. 4(K)) although medium fishes were more caught on the Caribbean coast (Fig. 4(L)). Total catches changed significantly regarding the season (Table 2) and were higher during the dry season (Fig. 4(A)). Catches of microcarnivorous, herbivorous, larger body-size and low fishing value fishes also changed significantly over time (Table 2). Microcarnivorous fishes were more caught in 2007 (Fig. 4(E)), the Year factor was not significant in other cases (Table 2). Catches of herbivorous, larger body-size and low fishing value fishes were higher during the dry season (Fig. 4(H, N, O)).

As specified in Section 2.3., a particular interest was given to the interactions between Protection and Location, Protection and Year and Protection and Season; the two latter were included in an interaction term Protection x Time. A significant interaction between Protection and Time was found for the total catches, for catches of Acanthuridae, herbivorous fishes, sedentary species, medium and large fishes and low fishing value species (Table 2). Figure 4(A, B, H, I, L, M, O) illustrates how the differences between FR and FZ are kept over time, but also the amplitude variations of these difference. A significant interaction between Protection and Location was found for Acanthuridae, Haemulidae, microcarnivorous, sedentary species, small fishes and low fishing value fishes (Table 2), indicating that the response to protection differed among the two FRs. Acanthuridae, sedentary species, small and low fishing value fishes responded strongly to protection at BR FR whereas there was no significant difference between FR and FZ at the Caribbean coast (Fig. 4(B, I, K, O)). Haemulidae and microcarnivorous species showed another trend in that catches were higher



inside the BR FR than outside. On the contrary, catches were higher outside the IR FR than inside (Fig. 4(E)) but these differences were not significant. In many cases, the Location factor interacted significantly with time indicating that Location effect changed over time.

Finally, we looked at the evolution of the catches within the FRs and the FZs over time. The results are presented in Tables 3-4. Even though we observed a decrease of the catches for all groups inside the BR FR between the dry and the wet seasons 2007 (Fig. 4), these differences were not significant (Table 3). At the opposite, except for larger body-size fishes, the catches for all groups significantly decreased within FZ between the dry and the wet season 2007 (Table 3). In addition, we did not catch any Haemulidae, microcarnivorous fishes and large body-size fishes in the FZ during the wet season 2007. In August 2007, the hurricane Dean hit the Martinique island and strongly impacted the Atlantic coast (Fig. 2) and the southwestern Atlantic. Our results suggested that fish assemblages were more sensitive in FZ than in FR to this environmental disturbance. Except for Haemulidae, microcarnivorous fishes, larger body-size fishes and medium fishing value fishes, catches for all groups were lower within the BR FR during the wet season 2007 than during the wet season 2008 (Table 3). In the same way, except for Lutjanidae, Haemulidae, macrocarnivorous and microcarnivorous fishes, large and larger body-size fishes and medium fishing value fishes, catches were lower inside the FZ during the wet season 2007 than during the wet season 2008 (Table 3).

Table 4 shows that the catches inside the IR FR are quite constant over time. Except for large and larger body-size fishes, which catches have sharply decreased (Fig. 4(M,N)), no significant changes occurred inside the Caribbean protected area between the dry and the wet seasons 2007 (Table 4). The IR FR was reopened to fishing from May to November 2007 and hurricane Dean has less impacted this zone as shown in Fig. 2. In addition, the decrease of catches observed inside the FZ between the dry and the wet seasons 2007 was not significant.

Total catches and catches of herbivorous fishes, sedentary species, medium fishes and low fishing value fishes decreased in the FZ between the dry and the wet seasons 2008 (Table 4). In October 2008, a strong swell induced by hurricane Omar, located in the Gulf of Mexico, strongly impacted the Caribbean coast of Martinique (Fig. 2). But the catches of species cited above, Acanthuridae and microcarnivorous were higher during the wet season 2008 compared to the catches from the wet season 2007. On the Caribbean coast, the most remarkable result was the constancy of the catches inside the FR compared to the catches from the FZ, but also compared to catches from the BR FR.

## Discussion

This study is the first evaluation of protection effects on exploited fish assemblages of two FRs established since a decade in Martinique. The protection status had strong effects on catches of several species both in the Caribbean and the Atlantic FRs. But species response to protection differed from one species to another, and the protection efficiency fluctuated between the two locations. The protection effects also evolved over time.

### *Target species response to protection*

We obtained greater total catches inside the FR than outside the FR for both the Caribbean and the Atlantic fishery reserves. However, the protection had different impacts on species. We also found that the species that responded to protection differed between locations. Herbivorous species, which have most contributed to total catches, showed a strong response to protection. Similar results showing higher abundances of Acanthuridae and Scaridae inside protected areas compared to the outside protected were found in Kenya (McClanahan et al., 2006b) and St. Lucia (Hawkins et al., 2006). Better grazing pressure in FRs, resulting from higher herbivorous abundances, is one of the control factors of algae overgrowth, reducing the

competition for space between corals and algae, thus facilitating coral recruitment (Mumby et al., 2006; Hughes et al., 2007). MRT with IndVal indicated that Acanthuridae were typical of the BR FR and Fig. 4(B) shows that the catches of Acanthuridae were weak in the combined Caribbean FR and FZ, while Scaridae characterized more the IR FR. The protection effect was weak in both locations for Lutjanidae in opposition to Haemulidae, for which we found that the protection effect was consistent at the BR FR. However the catches of Haemulidae were higher outside the IR FR. Polunin and Roberts (1993) observed greater biomasses of Haemulidae in a protected area in Saba but not in Belize and Tupper and Juanes (1999) observed more adults of Haemulidae in a marine reserve at Barbados. Protection had a positive effect on large body-size fishes. Larger sizes of exploited species have been found within protected areas in other studies (Begg et al., 2005b; Floeter et al., 2006) and a meta-analysis performed by Mosqueira et al. (2000) has concluded that larger body-size species responded strongly to protection in relation to the level of exploitation. A significant interaction between Protection and Time was found for sedentary species indicating a strong effect of protection. On the contrary, no significant interaction was found for mobile species while their catches were always higher inside the two FRs compared to the outside. These differences were significant in most of the sampling seasons (Fig. 4(J)). Nevertheless these results suggest that mobile species reacted to protection. In general marine reserves better protect sedentary species (Botsford et al., 2003) but in a recent study, Malvadkar and Hastings (2008) have proposed an age-structured diffusion model showing that marine reserves are also useful to protect species with large moving ranges, as long as their growth rate is larger in protected than unprotected areas. In addition, Chapman and Kramer (1999) found that emigration from the reserve did not compromise the increase of density and size of species in the Barbados Marine Reserve.

In this study, we used a combination of species groups defined on biological and exploitation criteria. Few studies assessed the protection effect at different levels of fish assemblages (Ferraris et al., 2005; Claudet et al., 2006; Kulbicki et al., 2007). In fact, in the literature, the effect of marine reserves has often been analyzed separately on species, family, trophic group or size group. Our approach provides complementary information and allows taking into account the whole exploited fish assemblages. In the present study, Serranidae were not analyzed alone because of low catch rates but were included in size and commercial value groups. Lutjanidae did not respond to protection but large fishes did and macrocarnivorous fishes did not although both of these groups included many species of Lutjanidae. The trophic groups followed the pattern of the dominant family of each group giving redundant results. However, this approach is helpful to determine the most explaining criterion and species that are the most sensitive to protection.

#### *Differences in reserves performance*

Differences were found in the structure of exploited fish assemblages between the Atlantic and the Caribbean locations deriving from differences in habitat characteristics (Nuñez Lara et al., 1998; Mellin et al., 2006). Our results suggest that the protection effects are different between the two reserves studied according to the species groups. The catches were significantly higher inside the FR than outside more often in the Atlantic FR than in the Caribbean one. The FR:FZ ratio, called protection index (Russ et al., 2005), was 7.02 and 3.35 for the Atlantic and the Caribbean total catches, respectively. This pattern changed when we examined the protection index per species group (Table 5). Just considering the total catches, it was tantalizing to link the effectiveness of protection to the size of the FR (BR FR: 983 ha, IR FR: 184 ha). Depending of the sources, some authors stated that larger reserves are more effective (Claudet et al., 2008) while others pointed out that the impacts of reserves do

not rely on the size (Halpern, 2003). In our study, the effectiveness of the FRs is not correlated to the size. We suggest that the difference in the efficiency between the FRs may be better explained by the habitat characteristics, the poaching history, the fishing effort in the FZs as raised by Côté et al. (2001) and the intensity of exploitation before the FRs establishment. A limitation of this study is that recent quantization of the fishing effort is unavailable neither for the studied areas nor for the Martinican fishing grounds in general. But according to Munro (1983), the fishing effort in Martinique is one of the strongest in the Caribbean and Gobert and Stanisière (1997) related a high relative fishing effort in areas including the Baie du Robert and Ilet à Ramier.

#### *Temporal variability of catches inside and outside the FRs*

Variations in catches inside and outside the two FRs were investigated considering the environmental disturbances and an anthropogenic impact (Fig. 2). Our results clearly show, firstly that catches changed in the FRs and the FZs according to seasons and secondly that this evolution did not follow the same pattern in the FRs and FZs.

The wet season 2007 was the worst fishing season in the Atlantic both for the FR and FZ. Catches significantly decreased in the FZ between the dry and the wet seasons 2007. Catches also decreased in FR but not significantly. The hurricane Dean (category 4 storm) hit Martinique on August 18<sup>th</sup> 2007, and strongly impacted especially the Atlantic coast and the southwest coast. Several studies described the impacts of hurricanes on fish assemblages. Woodley et al. (1981) and Kaufman (1983) observed changes in fishes behavior, distribution and abundances after hurricane Allen hit in Jamaica in 1981. They reported a sharp increase of large mobile fishes, a loss of the territoriality behavior and a diurnal activity of cryptic and nocturnal fishes. These modifications increase the catchability of fishes. Indeed, some fishermen operating in Baie du Robert reported important and unusual catches with

aggregates of Acanthuridae, Lutjanidae and Serranidae just a few days after the hurricane Dean hit Martinique. These captures were followed by very low catches often null suggesting that ecosystems in FR have better resisted the hurricane and that overexploitation exacerbates impacts of the hurricane and inversely. Our findings corroborate previous results suggesting that marine reserves or areas with effort regulation mitigate the influences of natural catastrophic disturbances (Allison et al., 2003; Hughes et al., 2007).

No significant differences in the FZ of the Caribbean location were noticed between the dry and the wet seasons 2007. Only catches of large and larger body-size fishes sharply decreased in FR. Two events occurred at Ilet à Ramier between the dry and the wet seasons 2007. The NTZ was unexpectedly opened to fishing from May to November 2007. And hurricane Dean less impacted this location due to its east exposure and the northwest trajectory of the hurricane. Our results would suggest that the decrease of the greater size classes derived from the opening of the NTZ to fishing, but we considered that it remained unclear. In Sumailon MPA in Philippines, Russ and Alcala (1989; 1998) found a decrease in density of large body-size target fishes after the opening of the MPA but during 18 months and after 10 years of protection. In the present study, 7 months is probably not sufficient to induce significant and sharp changes in the fish assemblages. In addition, information or data on the level of exploitation and how was distributed the fishing effort during the opening of the FR was unavailable, so that limited our interpretation of our results. In October 2008, the swell resulting from hurricane Omar in the Gulf of Mexico has strongly impacted the Caribbean coast of Martinique. We did not find any significant differences of catches in the FR while total catches and catches of several species groups significantly decreased in the FZ between the dry and the wet seasons 2008 and between the wet seasons 2007 and 2008. These results are consistent with those already discussed on the impacts of hurricane Dean on the Atlantic coast and support our conclusions on a greater stability of the fish assemblages inside

marine reserves against climatic disturbances. As an increase of the proportion of strong hurricanes is predicted with the climate change (Webster et al., 2005), more information is required on the additive effects of hurricanes and fishing on reef fish assemblages but also on the contribution of marine reserves in reef ecosystems resistance and resilience face to climatic disturbances.

#### *FRs and the management of the small-scale fisheries*

Our results showed that protection had strong positive effects on catches of several target species. But we could not conclude that these FRs benefit the surrounding fisheries. Indeed, the lack of baseline studies and data before the implementation of the FRs network is a limit to the analysis of the changes in the catches and the intensity and the distribution of the fishing effort. Thus the trend in the fishermen catches against time was unknown. Questions arise concerning the benefits of an increase of catches in the surrounding FZs. From our results, we considered that the FRs could potentially be an efficient tool for resources protection and small-scale fisheries management. The FRs network in Martinique covers 9.2% of the waters from 0 to 30 m depth. It accounts for 0.1% of protected areas in the EEZ (Exclusive Economic Zone) of Martinique. This percentage of fully protected marine areas within EEZ is higher than Barbados (<0.01%), Jamaica (<0.01%), Brazil (0.05%) or Trinidad & Tobago (<0.01%) but lower than Belize (2.4%), Cuba (0.77%) or Costa-Rica (0.42%) (Guarderas et al., 2008). Moreover, the network responds to the recommendation of Roberts et al. (2003) suggesting that a network of small reserves with a range of different sizes is better than few larger reserves. Two initial phases of the rainbow parrotfish *Scarus guacamaia* were captured (and released) inside the Atlantic FR. This observation is important because this species is classified as vulnerable in the UICN Red List of Threatened Species

(FISHBASE) and has been fished to ecological extinction in many areas of the Caribbean (Floeter et al., 2006).

Assessing the level of exploitation in the surrounding FZs is necessary for a better understanding of spillover processes that could occur from FR to FZ (Stelzenmüller et al., 2008) but also in order to take future decisions relative to fisheries management. Trap fisheries, with important fishing effort, is responsible for overfishing and impact the ecosystem structure (Hawkins et al., 2007). Similar results were obtained between a study comparing the catch-length structure among three islands of Lesser Antilles showing that smallest fishes were caught in Martinique (Gobert, 2000) and our results showing that the BR FR is mainly characterized by small and low value fishes (IndVal). These 10 years interval research works strengthen the idea of the unsustainability of small-scale fisheries in Martinique. Therefore, a regulation of the fishing effort and a development of conservation efforts outside the reserves are important to support the effectiveness of protection (Allison et al., 1998; McClanahan et al., 1999). Stefansson and Rosenberg (2005) highlighted that combining different control measures of the fishing effort was more efficient for fisheries management than just one type of control measures.

In addition, we argue that better communication between scientists and local fishermen communities is required to obtain the commitment of the latter, what is essential to the success of marine reserves (Francini-Filho et Moura, 2008a). Even though effects of the reopening of IR FR remained unclear, periodic opening of small protected areas may affect the long-term fisheries management (McClanahan et al., 2006b). Our study provides encouraging results on the use of FRs to protect the reef resources.

Acknowledgements



This work was made possible through grants from the Regional Council of Martinique. The authors thank the Marine Environment Observatory of Martinique and IFREMER for their technical and logistical supports. We thank Mr. Etna for the making of the experimental traps. We also thank the Maritime Administration for the fishing permit to sample in the fishery reserves. We are very grateful to Mr. Alphonse Altius and Mr. Louis Belvent, the fishermen who helped for the experimental fishing for their great patience and their advices. We are grateful to Jack Chernin for providing language help.

## References

- Abesamis R.A., Alcalá A.C. and Russ G.R. (2006) How much does the fishery at Apo Island benefit from spillover of adult fish from the adjacent marine reserve? *Fish Bull* **104**:360-375
- Allison G.W., Gaines S.D., Lubchenco J. and Possingham H.P. (2003) Ensuring persistence of marine reserves: catastrophes require adopting an insurance factor. *Ecol Appl* **13**:S8-S24
- Allison G.W., Lubchenco J. and Carr M.H. (1998) Marine reserves are necessary but not sufficient for marine conservation. *Ecol Appl* **8**:S79-S92
- Ashworth J.S. and Ormond R.F.G. (2005) Effects of fishing pressure and trophic group on abundance and spillover across boundaries of a no-take zone. *Biol Conserv* **121**:333-344
- Barrett N.S., Edgar G.J., Buxton C.D. and Haddon M. (2007) Changes in fish assemblages following 10 years of protection in Tasmanian marine protected areas. *J Exp Mar Biol Ecol* **345**:141-157
- Begg G.A., Mapstone B.D., Williams A.J., Adams S., Davies C.R. and Lou D.C. (2005) Multivariate life-history indices of exploited coral reef fish populations used to measure the performance of no-take zones in a marine protected area. *Can J Fish Aquat Sci* **62**:679-692
- Bianchi G., Gislason H., Graham K., Hill L., Jin X., Koranteng K., Manickchand-Heileman S.C., Paya I., Sainsbury K., Sanchez F. and Zwanenburg K. (2000) Impact of fishing on size composition and diversity of demersal fish communities. *ICES J Mar Sci* **57**:558-571

- Botsford L.W., Micheli F. and Hastings A. (2003) Principles for design of marine reserves. *Ecol Appl* **13**:S25-S31
- Chapman M.R. and Kramer D.L. (1999) Gradients in coral reef fish density and size across the Barbados marine reserve boundary: effects of reserve protection and habitat characteristics. *Mar Ecol Prog Ser* **181**:81-96
- Chiappone M., Sluka R. and Sealey K.S. (2000) Groupers (Pisces: Serranidae) in fished and protected areas of the Florida Keys, Bahamas and northern Caribbean. *Mar Ecol Prog Ser* **198**:261-272
- Claudet J., Osenberg C.W., Benedetti-Cecchi L., Domenici P., Garcia-Charton J.A., Perez-Rufaza A., Badalamenti F., Bayle-Sempere J., Brito A., Bulleri F., Culioli J.-M., Dimech M., Falcon J.M., Guala I., Milazzo M., Sanchez-Meca J., Somerfield P.J., Stobart B., Vandeperre F., Valle C. and Planes S. (2008) Marine reserves: size and age do matter. *Ecol Lett* **11**:481-489
- Claudet J., Pelletier D., Jouvenel J.-Y., Bachet F. and Galzin R. (2006) Assessing the effects of Marine Protected Area (MPA) on a reef fish assemblage in a northwestern Mediterranean Marine Reserve: Identifying community based indicators. *Biol Conserv* **130**:349-369
- Côté I.M., Mosqueira I. and Reynolds J.D. (2001) Effects of marine reserve characteristics on the protection of fish populations: a meta analysis. *J Fish Biol* **59**:178-189
- De' ath G. (2002) Multivariate regression trees: a new technique for modelling species-environment relationships. *Ecology* **83**:1105-1117
- DeMartini E.E., Friedlander A.M., Sandin S.A. and Sala E. (2008) Differences in fish-assemblage structure between fished and unfished atolls in the northern Line Islands, central Pacific. *Mar Ecol Prog Ser* **365**:199-215
- Dufrêne M. and Legendre P. (1997) Species assemblages and indicators species: the need for a flexible asymmetrical approach. *Ecol Monogr* **67**:345-366
- Dulvy N.K., Freckelton R.P. and Polunin V.C. (2004) Coral reef cascades and the indirect effects of predator removal by exploitation. *Ecol Lett* **7**:410-416
- Ferraris J., Pelletier D., Kulbicki M. and Chauvet C. (2005) Assessing the impact of removing reserve status on the Abore Reef fish assemblage in New Caledonia. *Mar Ecol Prog Ser* **292**:271-286
- Floeter S.R., Halpern B.J. and Ferreira C.E.L. (2006) Effects of fishing and protection on Brazilian reef fishes. *Biol Conserv* **128**:391-402

- Francini-Filho R.B. and Moura R.L. (2008a) Dynamics of fish assemblages on coral reefs subjected to different management regimes in the Abrolhos Bank, eastern Brazil. *Aquatic Conservation: Marine and Freshwater Ecosystems* **18**:1166-1179
- Francini-Filho R.B. and Moura R.L. (2008b) Evidence for spillover of reef fishes from a no-take marine reserve: An evaluation using the before-after control-impact (BACI) approach. *Fisheries Research* **93**:346-356
- Fraschetti S., Terlizzi A., Micheli F., Benedetti-Cecchi L. and Boero F. (2002) Marine protected areas in the Mediterranean Sea: objectives, effectiveness and monitoring. *Mar Ecol* **23**:190-200
- Friedlander A.M. and DeMartini E.E. (2002) Contrasts in density, size and biomass of reef fishes between the northwestern and the main Hawaiian islands: the effects of fishing down apex predators. *Mar Ecol Prog Ser* **203**:253-264
- García-Charton J.A., Pérez-Rufaza A., Sánchez-Jerez P., Bayle-Sempere J., Reñones O. and Moreno D. (2004) Multi-scale spatial heterogeneity, habitat structure, and effect of marine reserves on Western Mediterranean rocky reef fish assemblages. *Mar Biol* **144**:161-182
- Gerber L.R., Kaveiva P.M. and Bascompte J. (2002) The influence of life history attributes and fishing pressure on the efficacy of marine reserves. *Biol Conserv* **106**:11-18
- Glasby T.M. (1997) Analyzing data from post-impact studies using asymmetrical analyses of variance: A case study of epibiota on marinas. *Aust J Ecol* **22**:448-459
- Gobert B. (2000) Comparative assessment of multispecies reef fish resources in the Lesser Antilles. *Fish Res* **44**:247-260
- Gobert B. (1998) Density - dependent size selectivity in Antillean fish traps. *Fish Res* **38**:159-167
- Gobert B. (1992) Impact of the use of trammelnets on a tropical reef resource. *Fish Res* **13**:353-367
- Gobert B. (1990) Production relative des pêcheries côtières en Martinique. *Aquat Living Resour* **3**:181-191
- Gobert B. and Stanisière J.-Y. (1997) Répartition spatiale de l'effort de pêche aux nasses en Martinique (Antilles). *Aquat Living Resour* **10**:93-100
- Goñi R., Adlerstein S., Alavarez-Berastegui D., Forcada A., Renones O., Criquet G., Polti S., Cadiou G., Valle C., Lenfant P., Bonhomme P., Perez-Rufaza A., Sanchez-Lizaso J.-L., Garcia-Charton J.A., Bernard G., Stelzenmüller V. and Planes S. (2008) Evidence

- of spillover from six Western Mediterranean marine protected areas measured from artisanal fisheries. *Mar Ecol Prog Ser* **366**:159-174
- Graham N.A.J., Dulvy N.K., Jennings S. and Polunin N.V.C. (2005) Size-spectra as indicators of the effects of fishing on coral reef fish assemblages. *Coral Reefs* **24**:118-124
- Graham N.A.J., Evans R.D. and Russ G.R. (2003) The effects of marine reserve protection on the trophic relationships of reef fishes on the Great Barrier Reef. *Environ Conserv* **30**:200-208
- Guarderas A.P., Hacker S.D. and Lubchenco J. (2008) Current status of marine protected areas in Latin America and the Caribbean. *Conserv Biol* **22**:1630-1640
- Halpern B.J. (2003) The impact of marine reserves: Do reserves work and does reserve size matter? *Ecol Appl* **13**:117-137
- Halpern B.J. and Warner R.R. (2002) Marine reserves have rapid and lasting effects. *Ecol Lett* **5**:361-366
- Harborne A.R., Mumby P.J., Kappel C.V., Dahlgren C.P., Micheli F., Holmes K.E., Sanchirico J.N., Broad K., Elliot I.A. and Brumbaugh D.R. (2008) Reserve effects and natural variation in coral reef communities. *J Appl Ecol* **45**:1010-1018
- Hawkins J.P. and Roberts C.M. (2004) Effects of artisanal fishing on caribbean coral reefs. *Conserv Biol* **18**:215-226
- Hawkins J.P. and Roberts C.M. (2003) Effects of fishing on sex-changing Caribbean parrotfishes. *Biol Conserv* **115**:213-226
- Hawkins J.P., Roberts C.M., Dytham C., Schelten C. and Nugues M.M. (2006) Effects of habitat characteristics and sedimentation on performance of marine reserves in St. Lucia. *Biol Conserv* **127**:487-499
- Hawkins J.P., Roberts C.M., Gell F.R. and Dytham C. (2007) Effects of trap fishing on reef fish communities. *Aquatic Conservation: Marine and Freshwater Ecosystems* **17**:111-132
- Hsieh C., Reiss C.S., Hewitt R.P. and Suglhara G. (2008) Spatial analysis shows that fishing enhances the climatic sensitivity of marine fishes. *Can J Fish Aquat Sci* **65**:947-961
- Hughes T.P., Baird A.H., Bellwood D.R., Card M., Connolly S.R., Folke C., Grosberg R., Hoegh-Guldberg O., Jackson J.B.C., Kleypas J., Lough J.M., Marshall P., Nyström M., Palumbi S.R., Pandolfi J.M., Rosen B. and Roughgarden J. (2003) Climate change, human impacts, and resilience of coral reefs. *Science* **301**:958-960

- Hughes T.P., Rodrigues M.J., Bellwood D.R., Ceccarelli D., Hoegh-Guldberg O., McCook L., Moltschaniwskyj N.A., Pratchett M.S., Steneck R.S. and Willis B. (2007) Phase shifts, herbivory, and resilience of coral reefs to climate change. *Curr Biol* **17**:360-365
- Jackson J.B.C., Kirby M.X., Berger W.H., Bjorndal K.A., Botsford L.W., Bourque B.J., Bradbury R.H., Cooke R., Erlandson J., Estes J.A., Hughes T.P., Kidwell S., Lange C.B., Lenihan H.S., Pandolfi J.M., Peterson C.H., Steneck R.S., Tegner M.J. and Warner R.R. (2001) Historical overfishing and the recent collapse of coastal ecosystems. *Science* **293**:629-638
- Jennings S., Grandcourt E.M. and Polunin N.V.C. (1995) The effects of fishing on the diversity, biomass and trophic structure of Seychelles' reef fish communities. *Coral Reefs* **14**:225-235
- Kaufman L.S. (1983) Effects of hurricane Allen on reef fish assemblages near Discovery Bay, Jamaica. *Coral Reefs* **2**:43-47
- Koslow J.A., Hanley F. and Wicklund R. (1988) Effects of fishing on reef fish communities at Pedro Bank and Port Royal Cays, Jamaica. *Mar Ecol Prog Ser* **43**:201-212
- Kulbicki M., Sarramégnia S., Letourneur Y., Wantiez L., Galzin R., Mou-Tham G., Chauvet C. and Thollot P. (2007) Opening of an MPA to fishing: Natural variations in the structure of a coral reef fish assemblage obscure changes due to fishing. *J Exp Mar Biol Ecol* **353**:145-163
- Lenfant P. (2003) Demographic and genetic structures of white sea bream populations (*Diplodus sargus*, Linnaeus, 1758) inside and outside a Mediterranean marine reserve. *C.R. Biologies* **326**:751-760
- Malvadkar U. and Hastings A. (2008) Persistence of mobile species in marine protected areas. *Fish Res* **91**:69-78
- McClanahan T.R. and Kaunda - Arara B. (1996) Fishery recovery in a coral-reef Marine Park and its effect on the adjacent fishery. *Conserv Biol* **10**:1187-1199
- McClanahan T.R., Muthiga N.A., Kamukuru A.T., Machano H. and Kiambo R.W. (1999) The effects of marine parks and fishing on coral reefs of northern Tanzania. *Biol Conserv* **89**:161-182
- McClanahan T.R., Verheij E. and Maina J. (2006) Comparing the management effectiveness of a marine park and a multiple-use collaborative fisheries management area in East Africa. *Aquatic Conservation: Marine and Freshwater Ecosystems* **16**:147-165
- Mellin C., Ferraris J., Galzin R., Kulbicki M. and Ponton D. (2006) Diversity of coral reef fish assemblages: Modelling of the species richness spectra from multi-scale

- environmental variables in the Tuamotu Archipelago (French Polynesia). *Ecol Model* **198**:409-425
- Micheli F. and Halpern B.J. (2005) Low functional redundancy in coastal marine assemblages. *Ecol Lett* **8**:391-400
- Mosqueira I., Côté I.M., Jennings S. and Reynolds J.D. (2000) Conservation benefits of marine reserves for fish populations. *Anim Conserv* **4**:321-332
- Mumby P.J., Dahlgren C.P., Harborne A.R., Kappel C.V., Micheli F., Brumbaugh D.R., Holmes K.E., Mendes J.M., Broad K., Sanchirico J.N., Buch K., Box S., Stoffle R.W. and Gill A.B. (2006) Fishing, trophic cascades, and the process of grazing on coral reefs. *Science* **311**:98-101
- Munro J.L. (1983) *Caribbean coral reef fishery resources*. ICLARM Studies and Reviews 7, 276p, Manila, Philippines.
- Núñez Lara E. and Arias Gonzalez E. (1998) The relationship between reef fish community structure and environmental variables in the southern Mexican Caribbean. *J Fish Biol* **53**:209-221
- Parnell P.E., Lennert-Cody C.E., Geelen L., Stanley L.D. and Dayton P.K. (2005) Effectiveness of a small marine reserve in southern California. *Mar Ecol Prog Ser* **296**:39-52
- Pauly D., Christensen V., Guénette S., Pitcher T.J., Sumaila U.R., Walters C.J., Watson R. and Zeller D. (2002) Towards sustainability in world fisheries. *Nature* **418**:689-695
- Pauly D. and Froese R. (1991) Fishbase: assembling formation on fish. *NAGA, ICLARM Q* **14**:10-11
- Pérez-Ruzafa A., Gonzales-Wangüemert M., Lenfant P., Marcos C. and Garcia-Charton J.A. (2006) Effects of fishing protection on the genetic structure of fish populations. *Biol Conserv* **129**:244-255
- Perry A.L., Low P.J., Ellis J.R. and Reynolds J.D. (2005) Climate change and distribution shifts in marine fishes. *Science* **308**:1912-1915
- Polunin V.C. and Roberts C.M. (1993) Greater biomass and value of target species coral reef fishes in two small Caribbean marine reserves. *Mar Ecol Prog Ser* **100**:167-176
- Roberts C.M. (1995) Rapid build-up of fish biomass in a Caribbean marine reserve. *Conserv Biol* **9**:815-826
- Roberts C.M., Bohnsack J.A., Gell F.R., Hawkins J.P. and Goodridge R. (2001) Effects of marine reserves on adjacent fisheries. *Science* **294**:1920-1923

- Roberts C.M., Branch G., Bustamante R.H., Castilla J.C., Dugan J., Halpern B.J., Lafferty K.D., Leslie H., Lubchenco J., McArdle D., Ruckelshaus M. and Warner R.R. (2003) Application of ecological criteria in selecting marine reserves and developing reserve networks. *Ecol Appl* **13**:S215-S228
- Russ G.R. and Alcala A.C. (1989) Effects of intense fishing pressure on an assemblage of coral reef fishes. *Mar Ecol Prog Ser* **56**:13-27
- Russ G.R. and Alcala A.C. (1998) Natural fishing experiments in marine reserves 1983-1993: roles of life history and fishing intensity in family responses. *Coral Reefs* **17**:399-416
- Russ G.R., Alcala A.C. and Maypa A.P. (2003) Spillover from marine reserves: the case of *Naso vlamingii* at Apo Island, the Philippines. *Mar Ecol Prog Ser* **264**:15-20
- Russ G.R., Stockwell B. and Alcala A.C. (2005) Inferring versus measuring rates of recovery in no-take marine reserves. *Mar Ecol Prog Ser* **292**:1-12
- Seytre C. and Francour P. (2008) Is the Cape Roux marine protected area (Saint-Raphaël, Mediterranean Sea) an efficient tool to sustain artisanal fisheries? First indication from visual censuses and trammel net sampling. *Aquat Living Resour* **21**:297-305
- Stefansson G. and Rosenberg A.A. (2005) Combining control measures for more effective management of fisheries under uncertainty: quotas, effort limitation and protected areas. *Philos Trans R Soc Lond B Biol Sci* **360**:133-146
- Stelzenmüller V., Maynou F., Bernard G., Cadiou G., Camilleri M., Crec'hriou R., Criquet G., Dimech M., Esparza O., Higgins R., Lenfant P. and Pérez-Ruzafa A. (2008) Spatial assessment of fishing effort around European marine reserves: Implications for successful fisheries management. *Mar Pollut Bull* **56**:2018-2026
- Tupper M.H. and Juanes F. (1999) Effects of a marine reserve on recruitment of grunts (Pisces: Haemulidae) at Barbados, West Indies. *Environ Biol Fishes* **55**:53-63
- Underwood A.J. (1981) Techniques of analysis of variance in experimental marine biology and ecology. *Oceanography and Marine Biology. An Annual Review* **19**:513-605
- Wantiez L., Thollot P. and Kulbicki M. (1997) Effects of marine reserves on coral reef fish communities from five islands in New Caledonia. *Coral Reefs* **16**:215-224
- Webster P.J., Holland G.J., Curry J.A. and Chang H.R. (2005) Changes in tropical cyclone number and intensity in a warming environment. *Science* **309**:1844-1846
- White C., Kendall B.E., Gaines S., Siegel D.A. and Costello C. (2008) Marine reserve effects on fishery profit. *Ecol Lett* **11**:370-379
- Willis T.J. and Anderson M.J. (2003) Structure of cryptic reef fish assemblages: relationships with habitat characteristics and predator density. *Mar Ecol Prog Ser* **257**:209-221

Woodley J.D., Chornesky E.A., Clifford P.A., Jackson J.B.C., Kaufman L.S., Knowlton N., Lang J.C., Pearson M.P., Porter J.W., Rooney M.C., Rylaarsdam K.W., Tunnicliffe V.J., Wahle C.M., Wuff C.M., Curtis A.S.G., Dallmeyer M.D., Jupp B.P., Koehl M.R., Neigel J.E. and Sides E.M. (1981) Hurricane Allen's impact on Jamaican coral reefs. *Science* **214**:749-755



Table 1. Main characteristics of the Caribbean and the Atlantic studied fishery reserves (FRs)

FR	Location	Year of establishment	Size (ha)	Main habitats	Depth range (m)
Ilet à Ramier	Caribbean Sea	1999	184	Soft bottoms 70%	0-20
				<i>Thalassia</i> and <i>Syringodium</i> beds 10%	
Baie du Robert	Atlantic Ocean	2000	983	Coral reefs 7%	0-20
				Rocks 13%	
				Soft bottoms 70%	
				<i>Thalassia</i> and <i>Syringodium</i> beds 20%	
				Coral reefs 10%	

Table 2. Four-way ANOVAs table of total catches and catches of species groups

	Protection		Location		Year		Season		Interactions
	F	Sig	F	Sig	F	Sig	F	Sig	
Total catch	35.01	<0.001	1.21	NS	1.67	NS	4.99	0.029	PxY* LxY** LxS* PxS* PxL* LxY***
Acanthuridae	24.53	<0.001	0.99	NS	0.20	NS	1.71	NS	PxS* PxL* LxY***
Scaridae	16.02	<0.001	0.97	NS	0.63	NS	0.25	NS	LxY**
Lutjanidae	13.96	<0.001	0.55	NS	0.39	NS	2.83	NS	LxY* YxS*
Haemulidae	11.94	0.001	16.9	<0.001	2.06	NS	0.77	NS	PxL*
Macrocarniv.	13.30	<0.001	0.78	NS	0.02	NS	1.95	NS	NS
Microcarniv.	6.07	0.01	28.2	<0.001	8.71	0.004	0.69	NS	PxL*
Herbivorous	28.68	<0.001	0.01	NS	1.12	NS	4.49	0.03	PxS* LxY***
Sedentary	28.94	<0.001	7.01	0.01	3.27	NS	0.05	NS	PxL** PxY* LxY** YxS**
Mobile	23.92	<0.001	2.02	NS	0.07	NS	0.05	NS	NS
Small	8.15	0.005	5.67	0.02	0.30	NS	0.89	NS	PxL**
Medium	23.05	<0.001	5.09	0.02	0.12	NS	0.38	NS	PxS* LxY*
Large	17.42	<0.001	0.35	NS	0.70	NS	0.65	NS	PxS*
XLarge	5.86	0.01	1.02	NS	0.52	NS	7.41	0.008	NS
Low	48.45	<0.001	0.95	NS	0.33	NS	7.85	0.006	PxL** PxS**
Medium	13.27	<0.001	3.61	NS	2.47	NS	0.30	NS	NS
High	14.55	<0.001	0.01	NS	0.02	NS	0.06	NS	NS

<sup>a</sup> Macrocarniv.: macrocarnivorous and Microcarniv.: microcarnivorous

<sup>b</sup> For simplifying the interpretation of results, no significant interaction terms and three-way interactions were removed (Sig:significance, NS: no significant, \*p<0.05, \*\*p<0.01, \*\*\*p<0.001)

Table 3. Repeated-measures ANOVAs table of total catches and catches of species groups inside and outside the Atlantic fishery reserve

	FR				FZ			
	Dry07vs Wet07	Dry08vs Wet08	Dry07vs Dry08	Wet07vs Wet08	Dry07vs Wet07	Dry08vs Wet08	Dry07vs Dry08	Wet07vs Wet08
Tot. catch	ns	0.05 ↑	ns	0.05 ↑	0.020 ↓	ns	0.033 ↓	0.05 ↑
Acanthur	ns	0.05 ↑	ns	0.05 ↑	0.043 ↓	ns	ns	0.037 ↑
Scaridae	ns	ns	ns	0.05 ↑	0.040 ↓	ns	ns	0.030 ↑
Lutjanid	ns	0.034 ↑	ns	0.047 ↑	0.039 ↓	ns	ns	ns
Haemuli	ns	ns	ns	ns	ns	ns	ns	ns
MacroC	ns	ns	ns	0.05 ↑	0.039 ↓	ns	ns	ns
MicroC	ns	ns	ns	ns	ns	ns	ns	ns
Herbiv	ns	ns	ns	0.05 ↑	0.018 ↓	ns	ns	0.036 ↑
Sedent	ns	ns	ns	0.05 ↑	0.043 ↓	ns	ns	0.038 ↑
Mobile	ns	ns	ns	0.05 ↑	0.037 ↓	ns	ns	0.05 ↑
Small	ns	ns	ns	0.05 ↑	0.043 ↓	ns	ns	0.037 ↑
Medium	ns	ns	ns	0.05 ↑	0.020 ↓	0.034 ↑	0.033 ↓	0.046 ↑
Large	ns	ns	ns	0.05 ↑	ns	ns	ns	ns
XLarge	ns	ns	ns	ns	ns	ns	ns	ns
Low fv	ns	ns	ns	0.05 ↑	0.043 ↓	ns	ns	0.037 ↑
Med. fv	ns	ns	ns	ns	ns	ns	ns	ns
High fv	ns	ns	ns	0.05 ↑	0.039 ↓	ns	ns	0.05 ↑

<sup>a</sup> Tot.: total, Acanthur: Acanthuridae, Lutjanid: Lutjanidae, Haemuli: Haemulidae, MacroC: macrocarnivorous, MicroC: microcarnivorous, Herbiv: herbivorous, Sedent: sedentary, fv: fishing value, Med.: medium

<sup>b</sup> When differences are significant, the trend of catches is indicated by ↑ (increase) and ↓ (decrease).

Table 4. Repeated-measures ANOVAs table of total catches and catches of species groups inside and outside the Caribbean fishery reserve

	FR				FZ			
	Dry07vs Wet07	Dry08vs Wet08	Dry07vs Dry08	Wet07vs Wet08	Dry07vs Wet07	Dry08vs Wet08	Dry07vs Dry08	Wet07vs Wet08
Tot. catch	ns	ns	ns	ns	ns	0.018 ↓	0.28 ↓	0.021 ↓
Acanthur	ns	ns	ns	ns	ns	ns	ns	0.018 ↓
Scaridae	ns	ns	ns	ns	ns	ns	ns	ns
Lutjanid	ns	ns	ns	ns	ns	ns	ns	ns
Haemuli	ns	ns	ns	ns	ns	ns	ns	ns
MacroC	ns	ns	ns	ns	ns	ns	ns	ns
MicroC	ns	ns	ns	ns	ns	ns	ns	0.038 ↓
Herbiv	ns	ns	ns	ns	ns	0.04 ↓	ns	0.020 ↓
Sedent	ns	ns	ns	ns	ns	0.028 ↓	ns	0.018
Mobile	ns	ns	ns	ns	ns	ns	ns	ns
Small	ns	ns	ns	ns	ns	ns	0.028 ↓	0.038 ↓
Medium	ns	ns	ns	ns	ns	0.017 ↓	0.049 ↓	ns
Large	0.023 ↓	ns	ns	ns	ns	ns	ns	ns
XLarge	0.017 ↓	ns	0.034 ↓	ns	ns	ns	ns	ns
Low fv	ns	ns	ns	ns	ns	0.016 ↓	0.011 ↓	0.018 ↓
Med. fv	ns	ns	ns	ns	ns	ns	ns	ns
High fv	ns	ns	ns	ns	ns	ns	ns	ns

<sup>a</sup> Tot.: total, Acanthur: Acanthuridae, Lutjanid: Lutjanidae, Haemuli: Haemulidae, MacroC: macrocarnivorous, MicroC: microcarnivorous, Herbiv: herbivorous, Sedent: sedentary, fv: fishing value, Med.: medium

<sup>b</sup> When the differences are significant, the trend of catches is indicated by ↑ (increase) and ↓ (decrease)

Table 5. Protection index (FR:FZ ratio) for species groups for each location.

Species group	Atlantic	Caribbean
Acanthuridae	9.6	8.18
Scaridae	4.7	12
Macrocarnivorous	7.97	2.7
Herbivorous	5.63	9.62
Mobile species	4	3.5
High fishing value species	3.65	3.62

## Figure legends

Figure 1. Map of the network of FRs of Martinique showing the studied FRs and the sampling sites

Figure 2. Schema summarizing environmental and anthropogenic events occurred in the Atlantic and the Caribbean locations during the two-year survey

Figure 3. Multivariate regression tree showing the hierarchical organization of effects of Protection, Location, Year and Season on catches. The number of fishing events was reported for each split and each leaf.

Figure 4. Boxplots of (A) total catches, of catches of (B) Acanthuridae, (C) Scaridae, (D) Lutjanidae, (E) Haemulidae, (F) macrocarnivorous, (G) microcarnivorous, (H) herbivorous, (I) sedentary fishes, (J) mobile fishes, (K) small fishes, (L) medium fishes, (M) large fishes, (N) larger fishes, (O) fishes with low fishing value, (P) fishes with medium fishing value, and (Q) fishes with high fishing value for each location, each year, each season and each level of protection (white boxes: FZ and hatched boxes: FR). Results of one-way ANOVAs comparing differences between the FR and FZ for each season, each year and each location are given (ns: no significant, \* $p < 0.05$ , \*\* $p < 0.01$ , \*\*\* $p < 0.001$ )

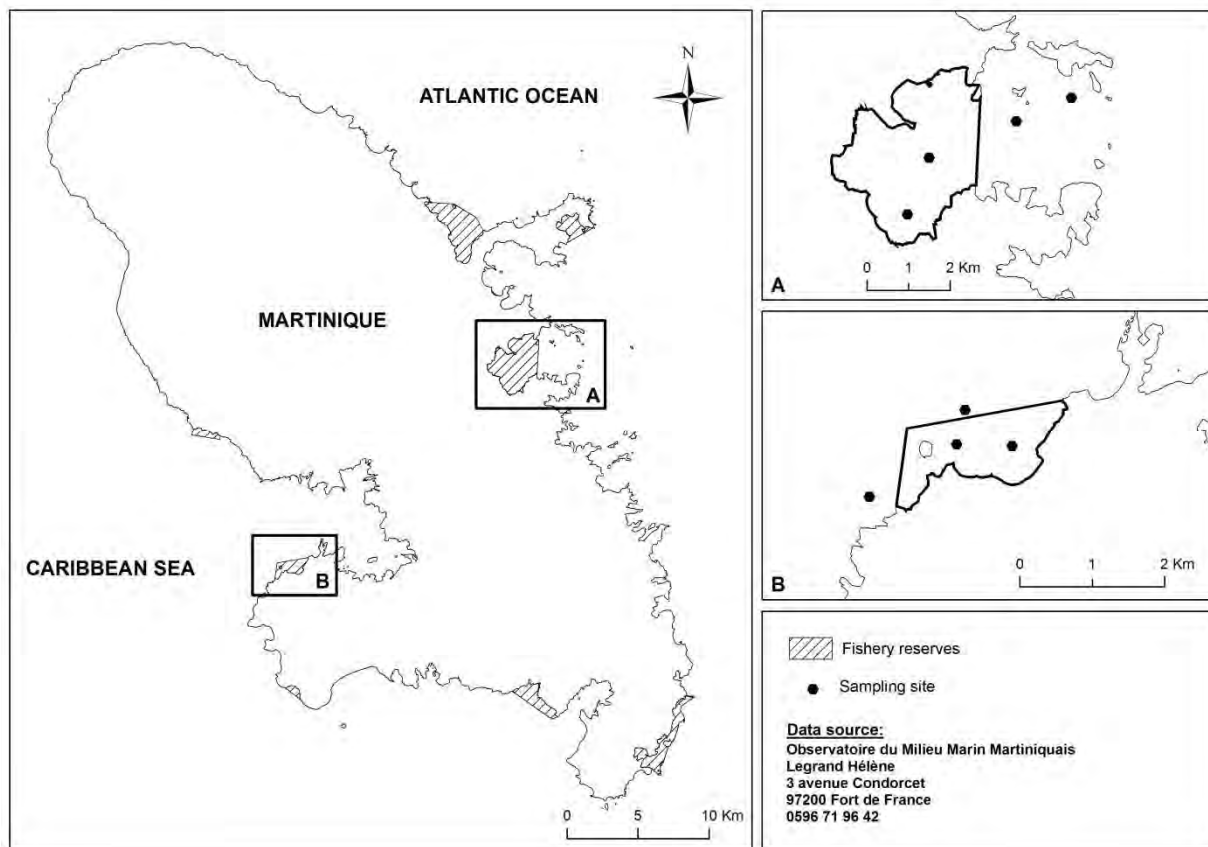


Figure 1

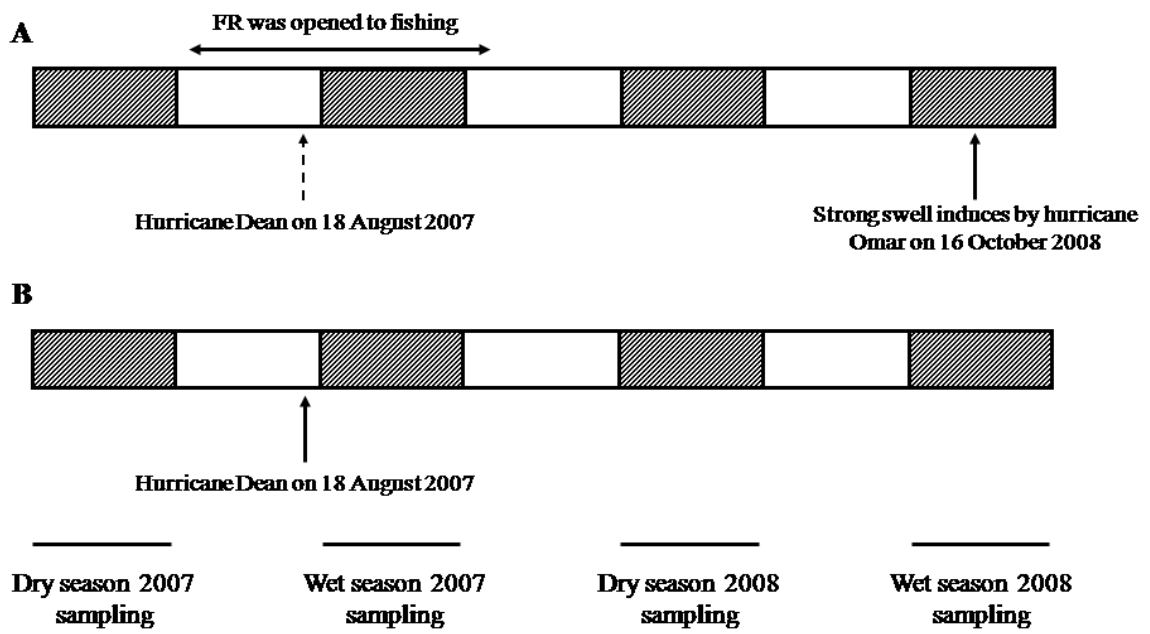


Figure 2

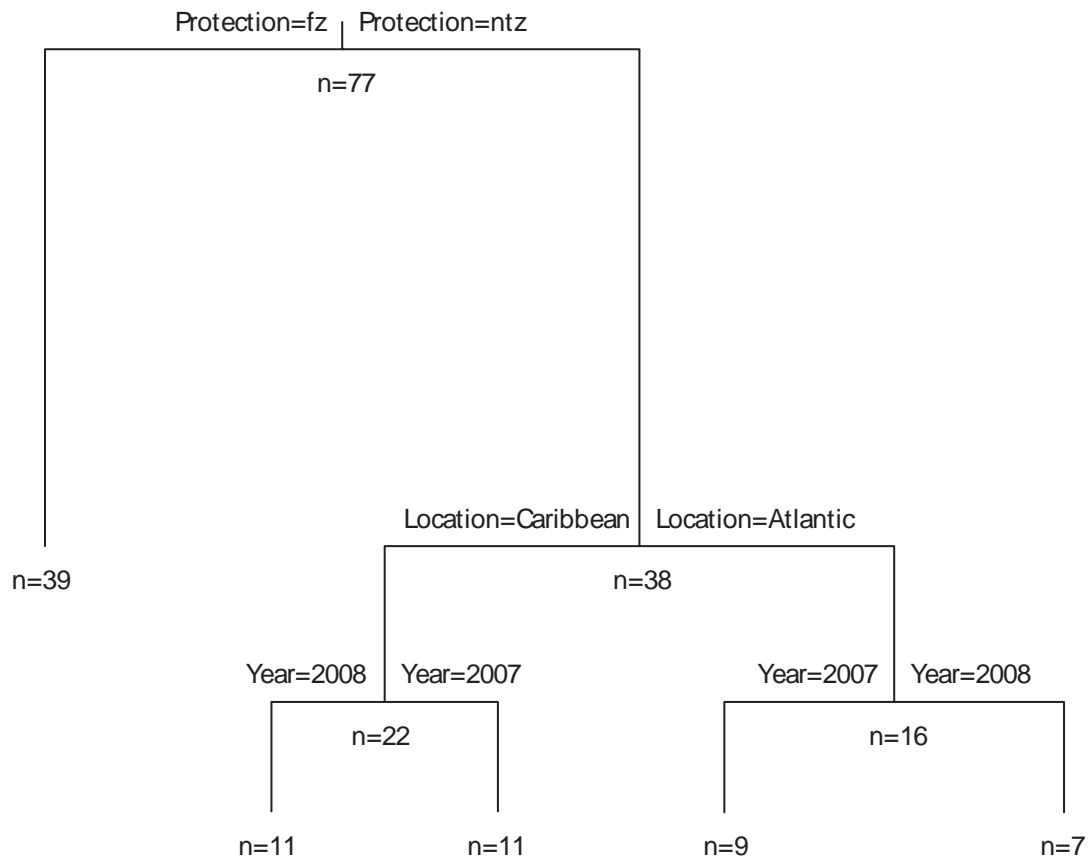


Figure 3



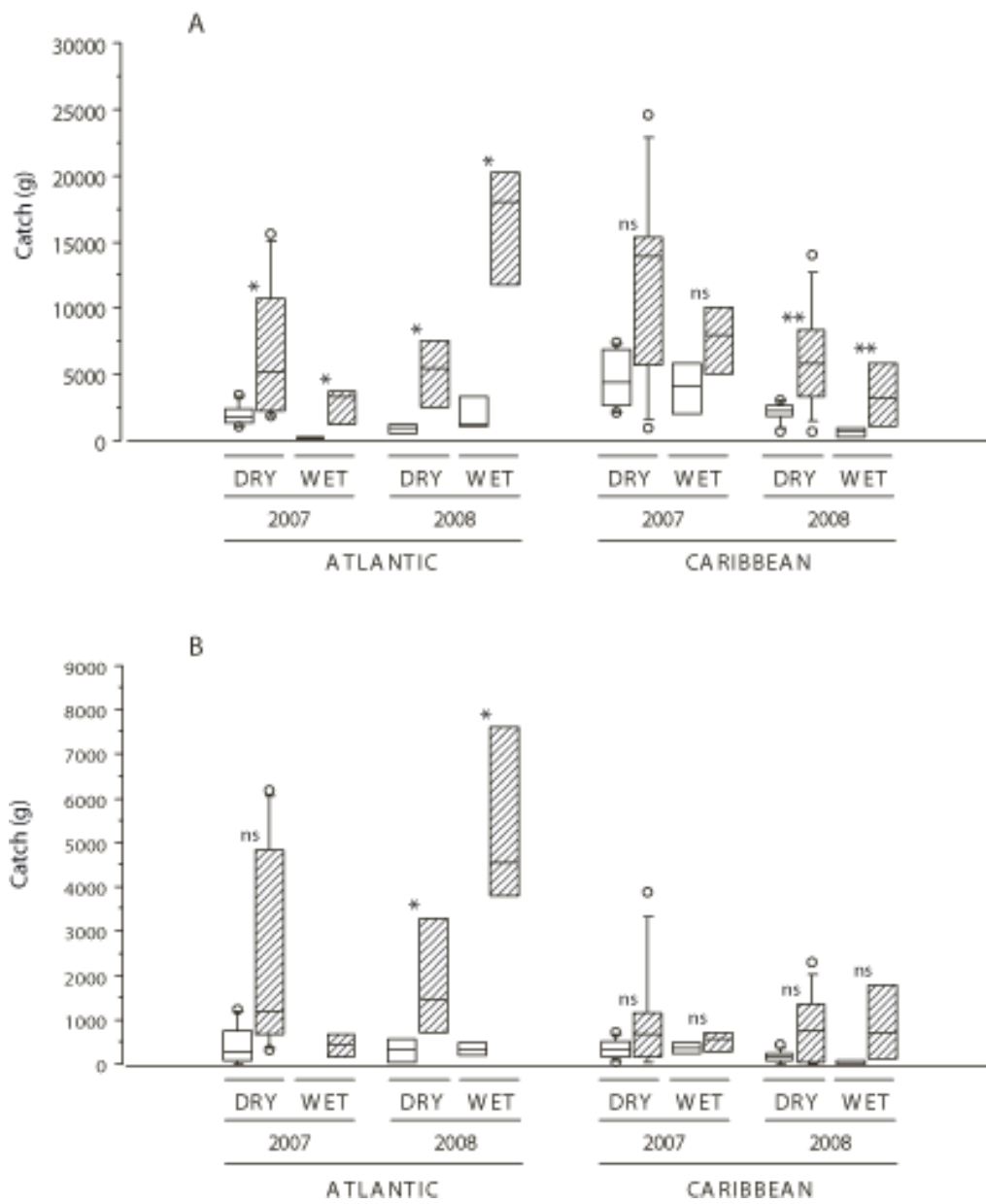


Figure 4 (continued)

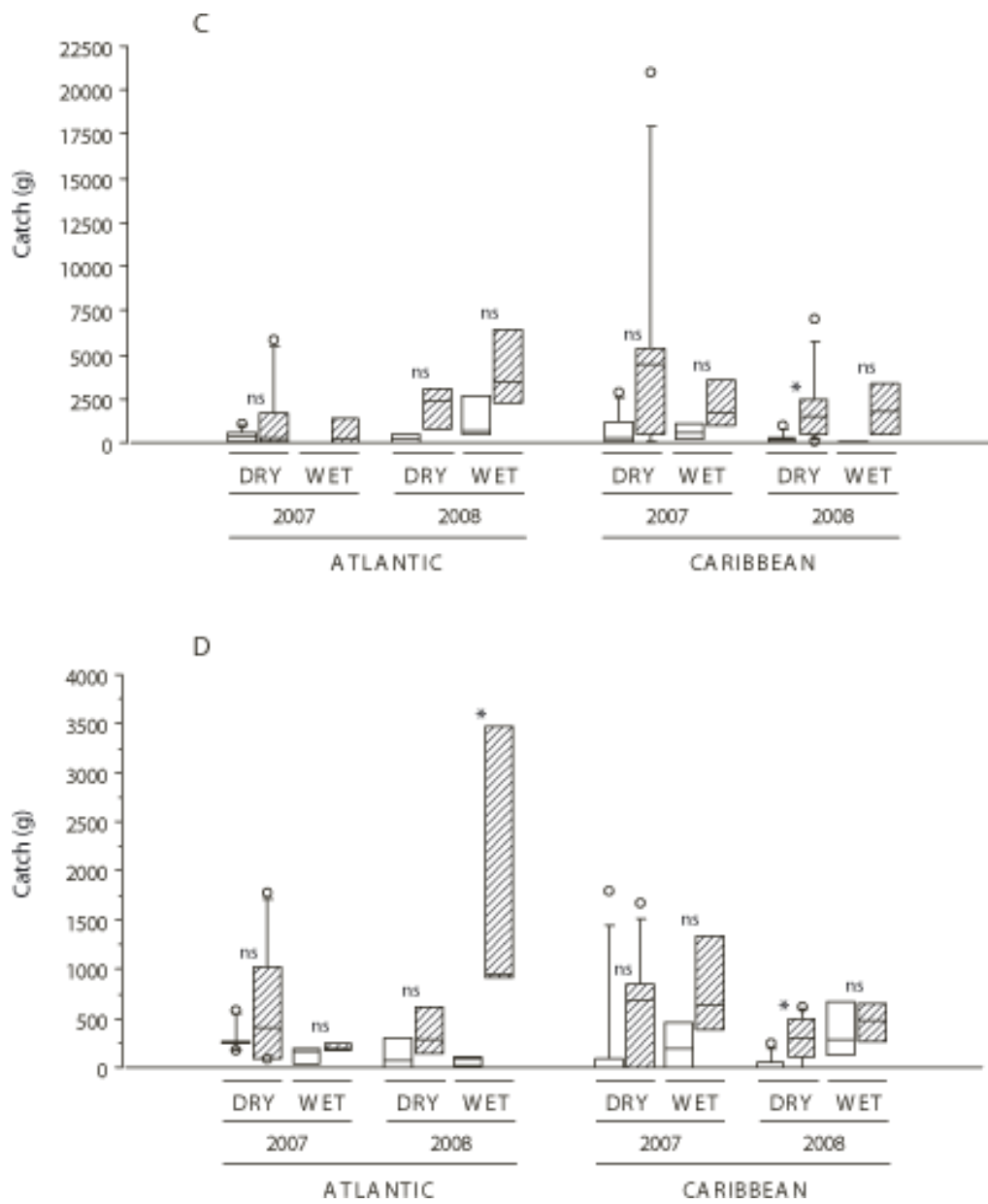


Figure 4 (continued)

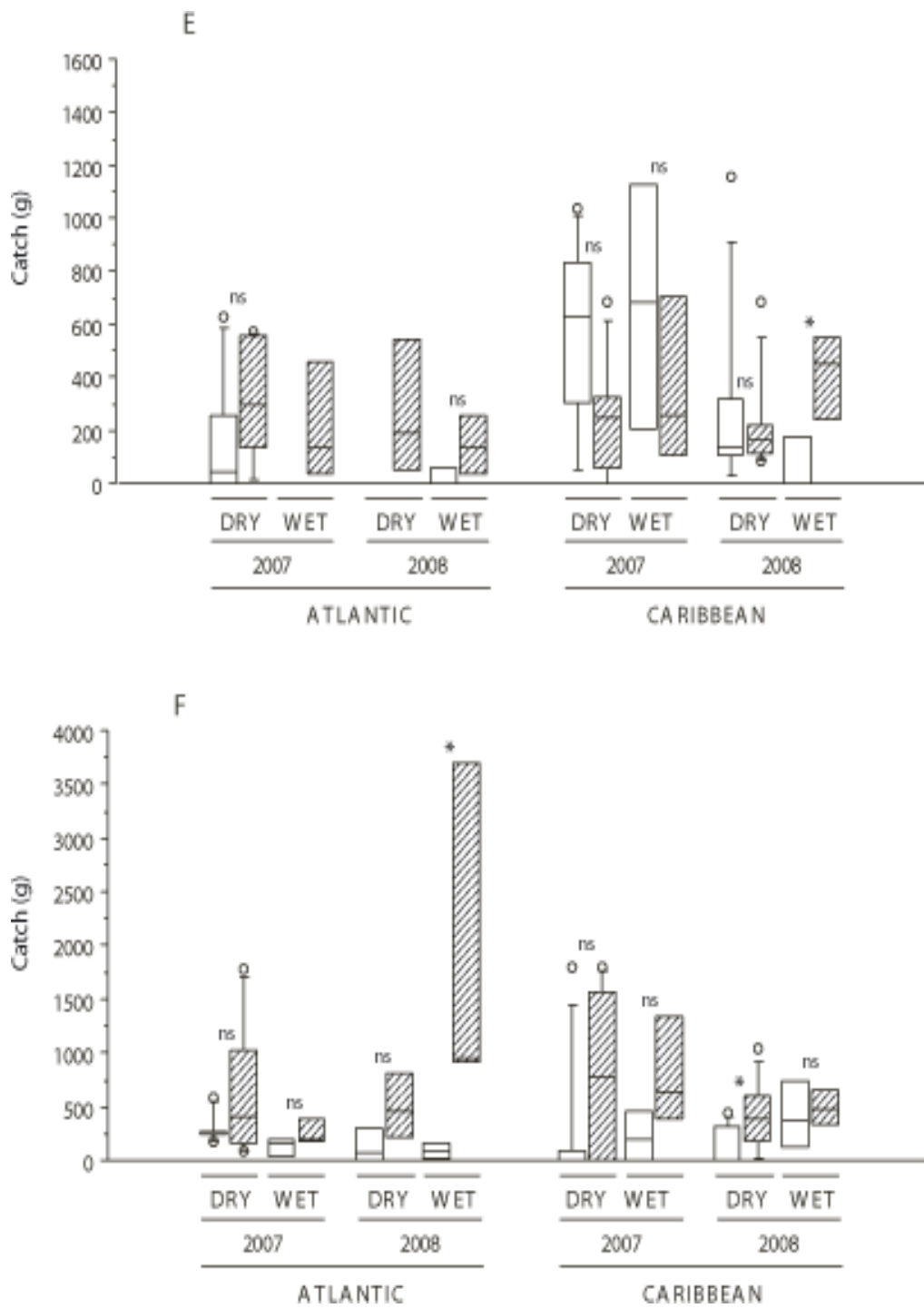


Figure 4 (continued)

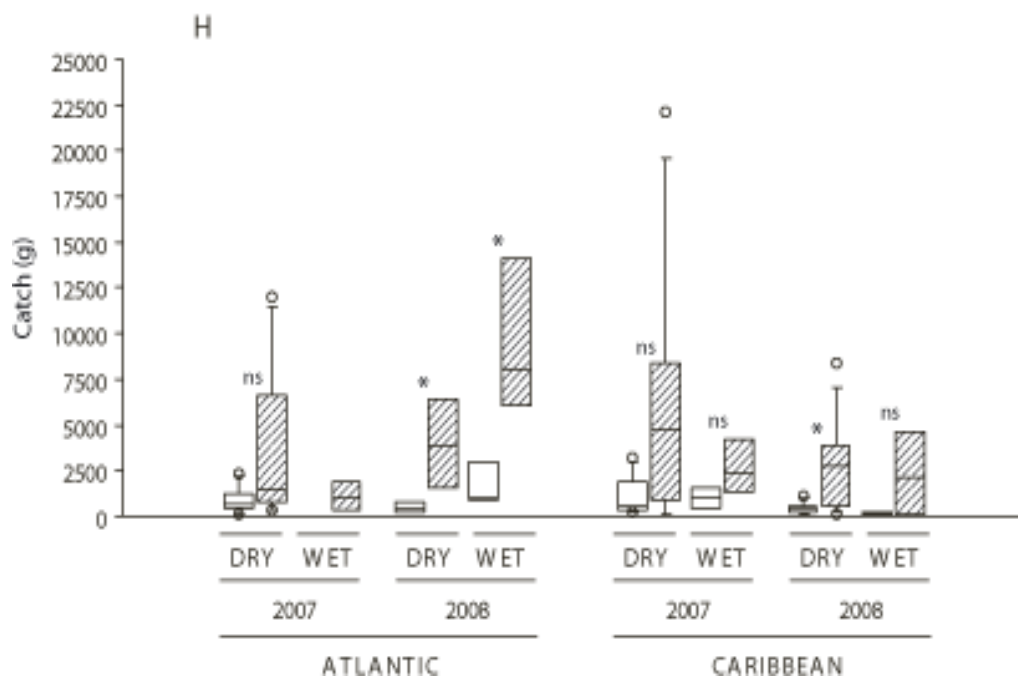
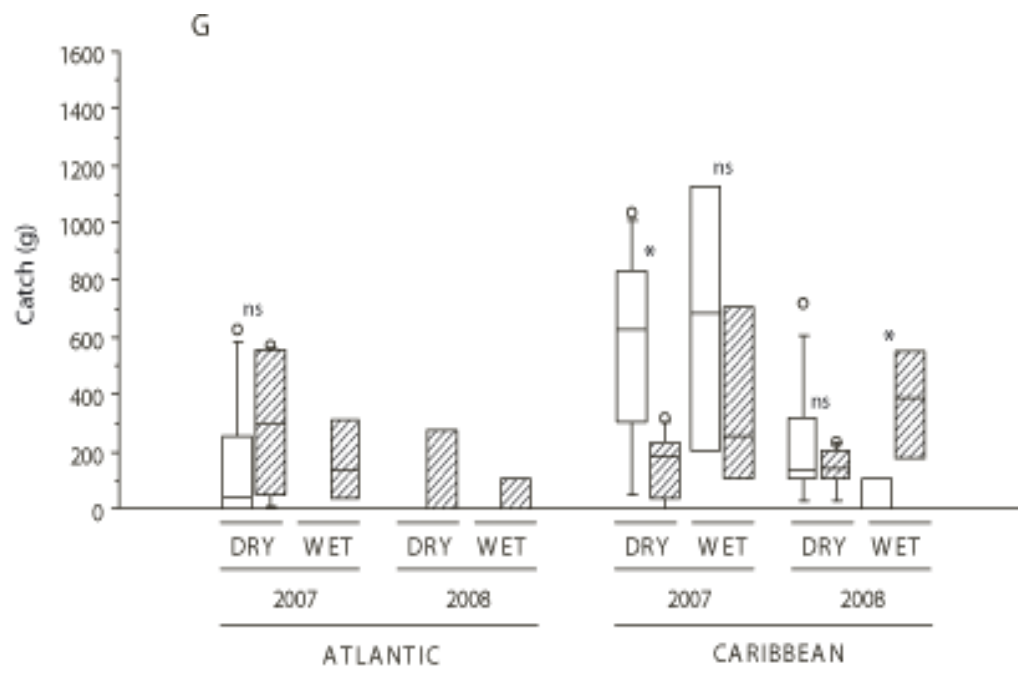


Figure 4 (continued)

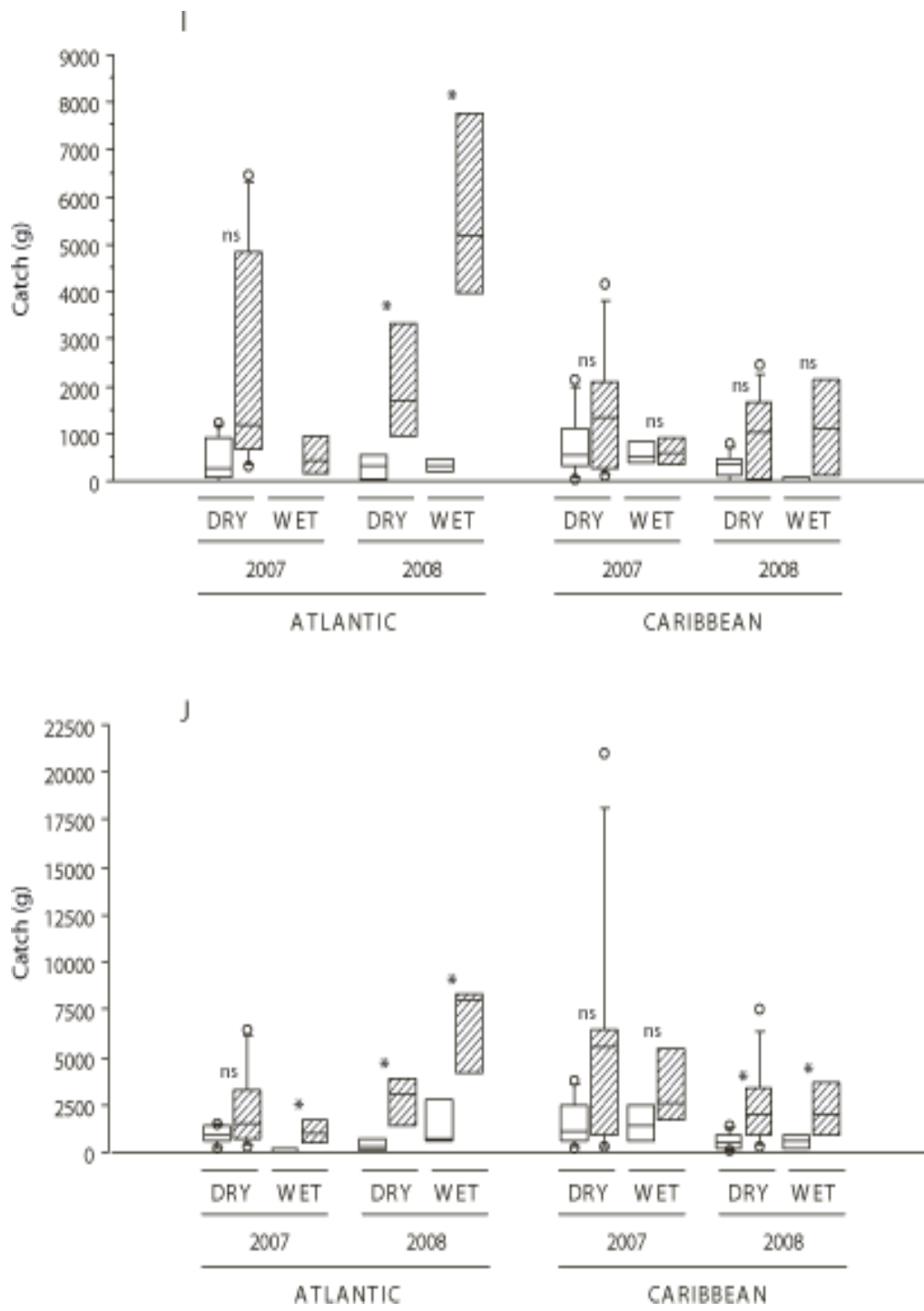


Figure 4 (continued)

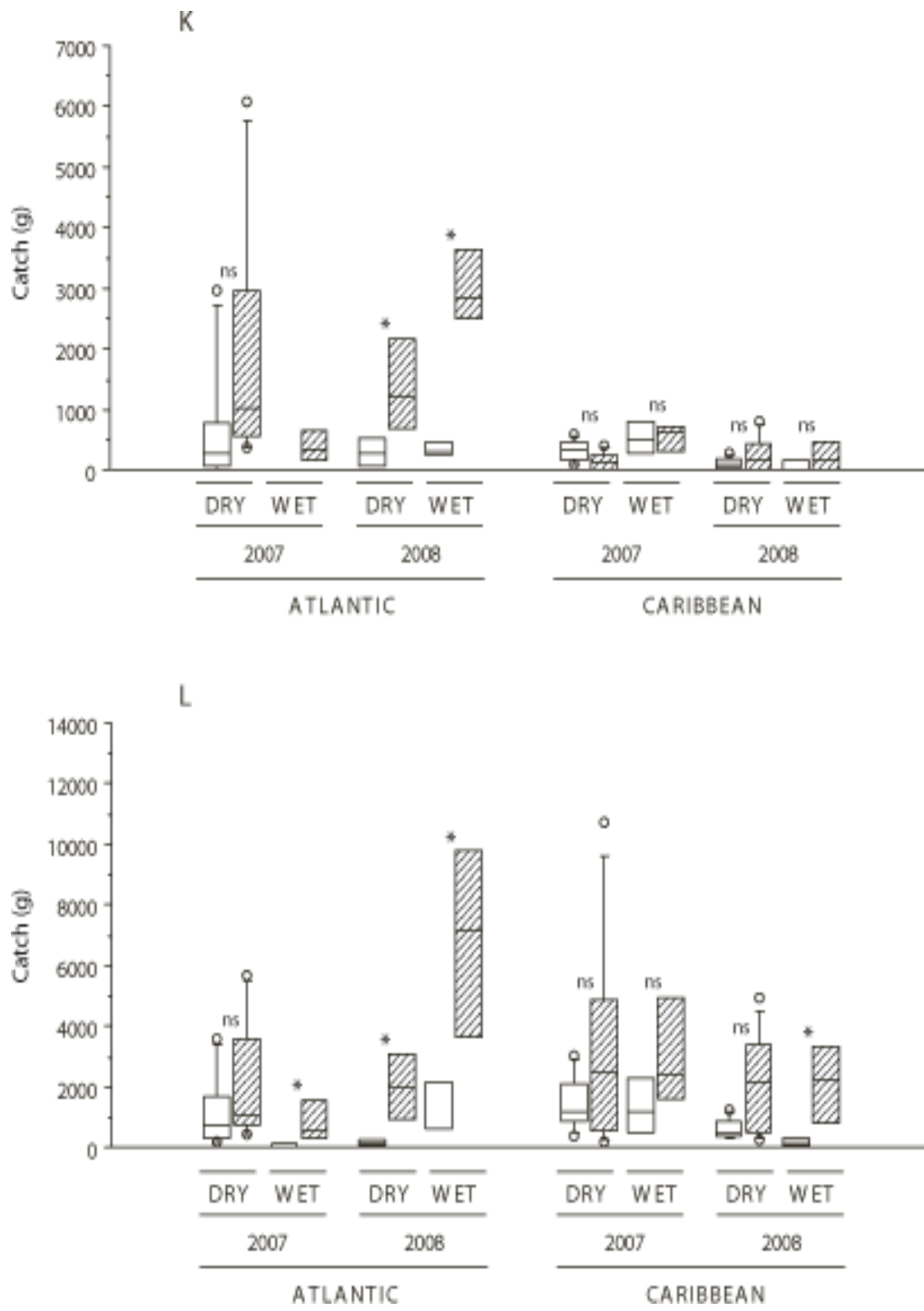


Figure 4 (continued)

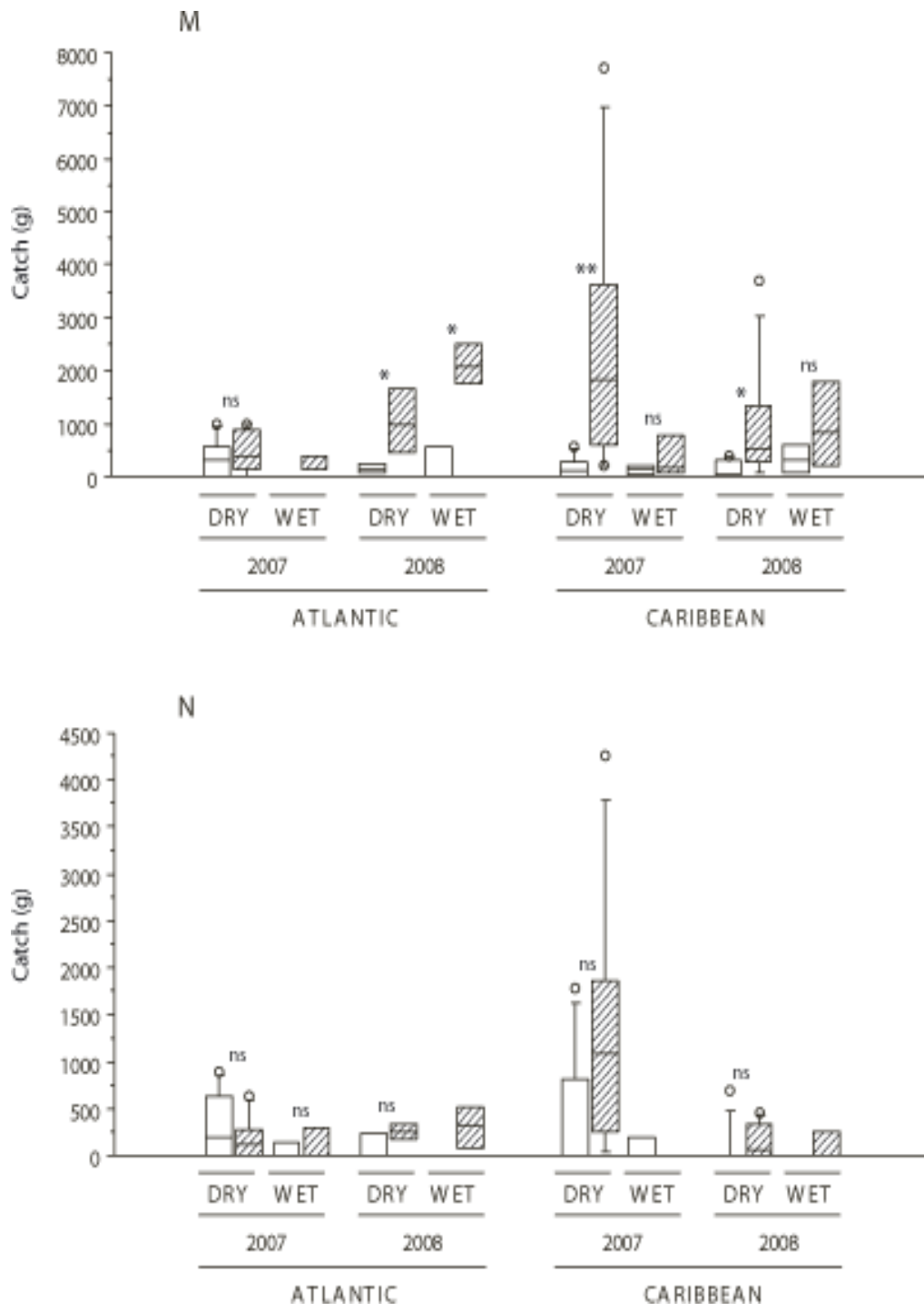


Figure 4 (continued)

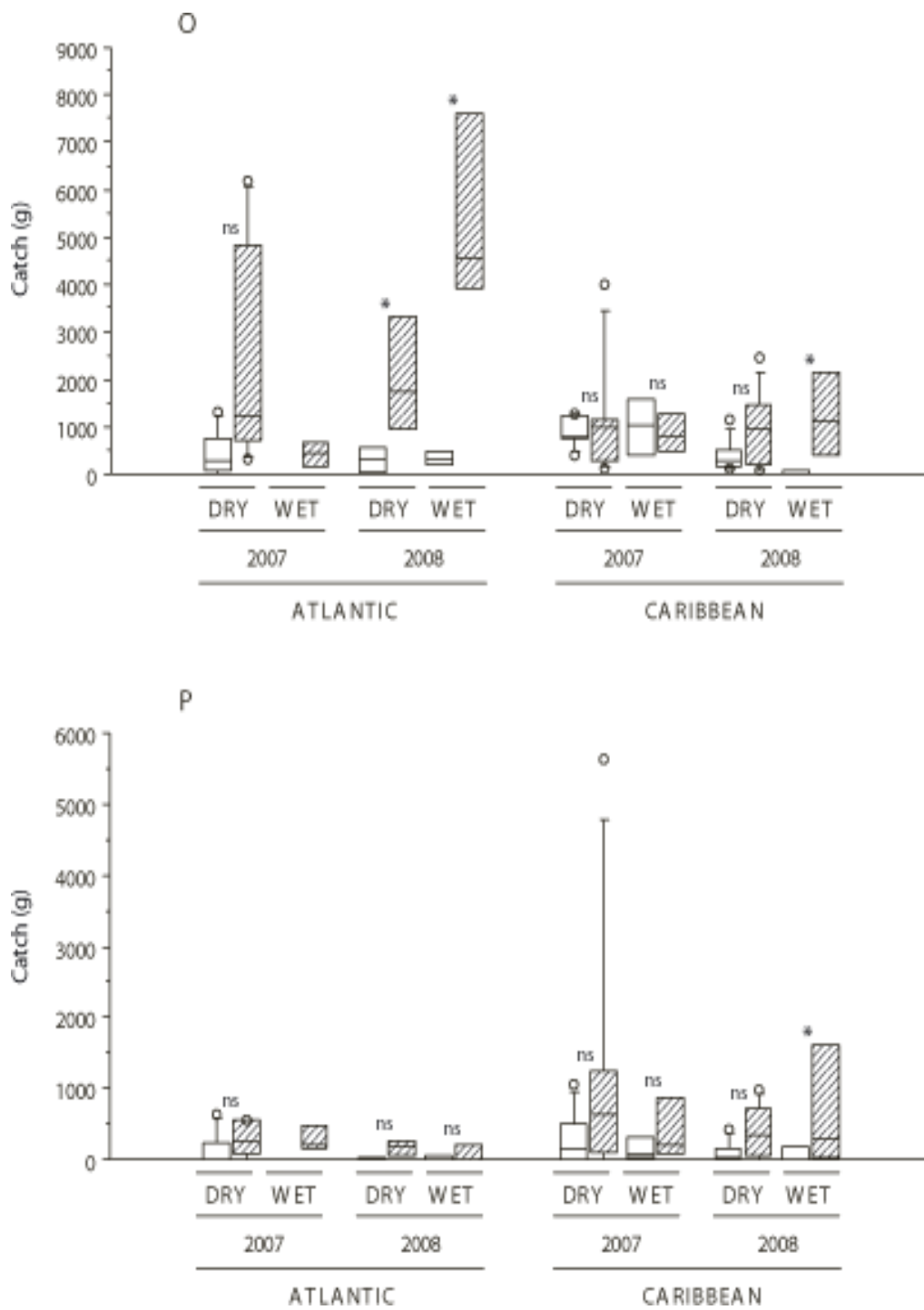


Figure 4 (continued)



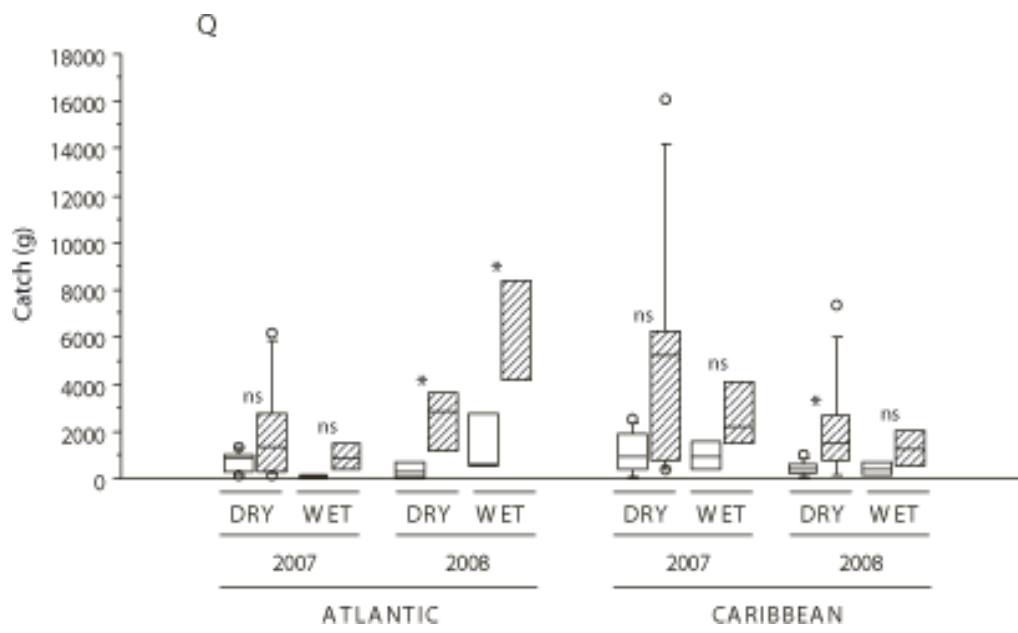


Figure 4

## **CHAPITRE IV**

### **Catch-length structure of reef fishes as an indicator of the protection effects in Martinique**

Géraldine CRIQUET<sup>a\*</sup>, Jessica GARCIA<sup>a</sup>, Jean-Philippe MARECHAL<sup>b</sup>, Lionel REYNAL<sup>c</sup>,  
Philippe LENFANT<sup>a</sup>

<sup>a</sup>UMR 5244 CNRS-EPHE-UPVD Center of Tropical and Mediterranean Biology and Ecology, 52 Avenue Paul Alduy Perpignan University 66860 Perpignan Cedex France

<sup>b</sup>Marine Environment Observatory of Martinique, 3 Avenue Condorcet 97200 Fort-de-France Martinique France

<sup>c</sup>IFREMER Robert Station Pointe Fort 97231 Le Robert Martinique France

\*Corresponding author: [geraldine.criquet@univ-perp.fr](mailto:geraldine.criquet@univ-perp.fr)

Tél: +33 4 68 66 20 55; Fax: +33 4 68 36 86

**Keywords-** Caribbean, Size structure, Reef fishes, Marine reserves, Trap fishing, Mesh size

(submitted to *Coral Reefs*)

## **Abstract**

This study examined the catch–length structure of reef fishes inside and outside protected areas to assess protection effects. Experimental trap fishing was conducted during two years inside and outside two fishery reserves in Martinique. Length structure analysis was performed and the size at first maturity of the selected species was established. Species with low trophic level were dominant in the catches inside and outside both fishery reserves. Larger fishes were caught inside the protected areas. Greater mean length of *Acanthurus bahinaus*, *A. chirurgus*, *Sparisoma aurufrenatum*, *Mulloidichthys martinicus*, *Holocentrus rufus* and *Cephalopholis fulva* were observed inside the fishery areas whereas the length of *S. chrysopterum*, *S. viride*, *Haemulon flavolineatum*, *Ocyurus chrysurus* and *Lutjanus synagris* did not differ between protected and unprotected areas. Many immature fishes were caught especially in the fishing zones. Our results suggested that marine reserves are important for the sustainability of resources but complementary conservation measures are required outside the protected areas. Catch-length structure was a powerful indicator of protection effect.

## **Introduction**

Coral reefs associated small-scale fisheries are essential for food supplies and economical and cultural activities of many countries. Overfishing is blamed for being the first major human disturbance affecting worldwide marine coastal ecosystems (Jackson et al., 2001). Fishing activities impact the structure of fish communities through the decrease of abundances of target species (Jennings et al., 1995; Tuya et al., 2006), changes in species composition (DeMartini et al., 2008) and in size structure (Jennings et al., 1999). The size structure is considered as a good indicator of fishing effects on fish communities (Dulvy et al., 2004b) since the species and individuals length are determinant in ecological, population dynamic and exploitation processes (Pope et al., 1994; Pauly et Watson, 2005). Thus, a relationship between the decline of larger body size species and the exploitation intensity has been observed (Gislason et Rice, 1998; Hawkins et Roberts, 2004; Graham et al., 2005) as well as the decrease of mean length of target species with an increase of fishing pressure (Hawkins et Roberts, 2003).

Face to an uncertain future of most marine resources and fisheries, marine reserves are increasingly considered as an efficient tool for resource protection and fisheries management (Roberts et al., 2001; Pauly et al., 2002). Protection benefits to fish communities, including higher density, biomass and mean size within the protected areas, have been well documented (McClanahan et Kaunda - Arara, 1996; Denny et al., 2004; Claudet et al., 2006; Barrett et al., 2007; Nguyen et Phan, 2008). Several studies observed larger fishes inside marine reserves. Chiappone et al. (2000) found higher density of larger groupers inside Caribbean protected areas and lightly fished areas. Size of target species increased in the Barbados Marine Reserve (Chapman et Kramer, 1999) and larger groupers and parrotfishes were found in Brazilian protected areas (Floeter et al., 2006).

Like in many islands of the Caribbean region, small-scale fisheries in Martinique are characterized by an intensive exploitation of reef fish resources dominated by the use of non-selective traps which produce around 70% of the benthic catches (Gobert, 1990). Face to the depletion of coastal fish stocks and the decrease of fishing yields, the local Authorities have decided to establish a network of fishery reserves around the island between 1999 and 2005 to sustain coastal small-scale fisheries. No study has yet been investigated the effects of these protected areas on the exploited reef fish communities. The present study evaluates the response of reef fishes to protection by examining the catch-length structure inside and outside two fishery reserves.

## **Materials and Methods**

### **Study sites and data collection**

The study was conducted in Ilet à Ramier (IR) and Baie du Robert (BR) fishery reserves located on the leeward (west) and the windward (east) coasts of Martinique, respectively (Fig. 1, Table 1.). Experimental fishing were performed using unbaited double funnel Antillean-Z traps mesh-sized 31mm, the legal minimum mesh size in Martinique which is the lowest in Caribbean (Fig. 2). Fishing campaigns were conducted during the dry (March and April) and the wet (September and October) seasons in 2007 and 2008. Each fishing event consisted of 2 sites within the fishery reserves (FRs) and 2 sites in the surrounding fishing zones (FZs) with 2 traps per site (Fig. 1). Traps were set during five days at the same depth, within the bathymetric strata from 10 to 20 m, and on similar habitats in FRs and FZs. For each trap hauled, total length (cm) were recorded for each fish. Gonads of Acanthuridae, Scaridae, Haemulidae, Lutjanidae and Serranidae were macroscopically examined for sexual and maturity determination.

### **Data processing**

The samples were pooled over time to allowed having sufficient data for size distribution analysis. Following Gobert (1998), all individuals were split into six size classes to examine the size composition of whole catch inside and outside the protected areas. Species length-structure analysis was limited by the size of samples, i.e. the species composition of catches inside and outside each fishery reserve (Table 2.). Thus, 11 target species were retained for length-structure analysis, and sexes were pooled because of the extreme variability of catches. Mann-Whitney test was applied to compare species size between FRs and FZs. Prior to analysis, data were examined for normality using Kolmogorov and Smirnov test and Levene test was used to explore the homogeneity of variances. When it was possible, size at first maturity was established for the selected species for overall catches.

## **Results**

### **Catches composition**

A total of 55 species belonging to 18 families were caught during the experimental trap fishing campaigns. Predominant species caught in the experimental traps are shown in Table 2 both for protected and fished areas. In IR FR, herbivorous fishes dominated amongst which *Acanthurus bahianus* and *Sparisoma aurofrenatum* representing 10.6% and 22.1% of catches, respectively. Catch composition differed in IR FZ. Indeed, catches of *Holocentrus rufus*, *Myripristis jacobus* and *Haemulon flavolineatum* accounted for 41.3% of catches. In BR FR, *Acanthurus bahianus*, *Acanthurus chirurgus* and *Holocentrus rufus* were the most abundant species with 46% of the total catch. In BR FZ, catches were dominated by *Acanthurus chirurgus*, *Holocentrus rufus*, *Sparisoma chrysopterum* and *Sparisoma viride* which accounted for 67.4% of the total catch.

### **Size structure of catches and size at maturity**

The shape of the length-frequency curves of total catches was similar between protected and unprotected areas, but also between Caribbean and Atlantic coasts (Fig. 3). The distributions

were unimodal with a mode at the size class 16-20 cm except for BR FZ where the mode was moved back to the size class 11-15 cm. For both FRs, fishes belonging to the size class 21-25 cm contributed to approximately 30% of catches, whereas in both FZs the two dominant size classes were 11-15 cm and 16-20 cm. Less than 2% of fishes caught were more than 30 cm whatever the considered area. Fishes larger than 20 cm have contributed to 33.92%, 21.53%, 30.02% and 11.25% of catches of IR FR, IR FZ, BR FR, and BR FZ, respectively.

Length-frequency distributions of the selected species are presented in Fig. 4. They differed among species but also between FR and FZ and between Atlantic and Caribbean coasts. The length of *A. bahianus* was significantly higher in IR FR (Table 3). In addition, the mean length in FZ was lower than the size at maturity (Table 4) and approximately 50% of the fishes caught in FZ were immature against less than 30% in FR. The size class 10-13 cm contributed to approximately 80% of BR FZ catch whereas around 60% of fishes caught in BR FR belonged to the size class 13-16 cm. *A. bahianus* length was significantly higher in BR FR (Table 3) but the mean length of fishes caught outside as well as inside BR protected area was lower than size at maturity (Table 4). The frequency of *A. chirurgus* caught in IR FR in each size class was equivalent while 70% of fishes caught in IR FZ belonged to the size class 10-13 cm. Thus, the length of *A. chirurgus* was significantly higher in IR FR (Table 3). Approximately 95% of the fishes caught in traps in IR FZ were immature. The length-frequency distribution of *A. chirurgus* at BR presented the same profile as *A. bahianus* at BR. More than 90% of *S. aurofrenatum* caught in IR FZ belonged to the size class 15-18 cm while larger fishes were caught in IR FR (Fig. 4, Table 3). 97% of *S. aurofenatum* caught at IR were mature (Table 4). The lowest size classes (14-16 and 16-18 cm) contributed approximately to 70% and 90% of *S. viride* catches in BR FR and in BR FZ, respectively. The length was higher in BR FR than in BR FZ but the difference was not significant (Table 3). None mature fish was caught neither inside nor outside BR protected area (Table 4). Concerning *S.*



*chrysopterum* at IR, fishes from the size classes 15-18 and 18-21 cm dominated in FR whereas fishes from the size classes 21-24 and >24 cm dominated in FZ. Thus, the length was higher outside the protected area but the difference was not significant (Table 3). In BR FR, catches were dominated by the lowest size class whereas 18-21 cm sized fishes dominated in the catches outside the protected area. The length of *S. chrysopterum* did not differ between BR FR and BR FZ (Tables 3) and was higher than the size at maturity (Table 4). Approximately 70% of *Mulloidichthys martinicus* caught in IR FR and 85% caught in IR FZ belonged to the size classes 20-22 and 22-24 cm and to the size classes 18-20 and 20-22 cm, respectively. The length was significantly higher inside the protected area (Table 3.) and the tree-quarters of the fishes caught were mature (Table 4). Approximately 40% of *H. rufus* caught in IR FZ measured between 18 and 20 cm whereas more than 30% of the fishes caught in IR FZ measured more than 22 cm. The length of *H. rufus* was significantly higher inside the IR protected area (Table 3). 80% of *H. rufus* caught in BR FZ belonged to the size class 18-20 cm whereas the size classes 18-20 and 20-22 cm each contributed to 40% of *H. rufus* catches in BR FR (Fig. 4). The length was significantly higher inside the protected BR area (Table 3). Most of *H. rufus* fished were mature whatever protected and unprotected areas (Table 4). The length-frequency distribution of *H. flavolineatum* presented the same profile inside and outside the IR fishery reserve. The size classes 14-16 and 16-18 cm accounted for 95% and 85% of *H. flavolineatum* catches in IR FR and in IR FZ, respectively. There was no difference in the length between the protected and the unprotected area (Table 3) and the tree-quarters of the fishes caught were mature (Table 4). Fishes from the size classes 19-21 and 21-23 cm dominated in *Ocyurus chrysurus* catches in IR FZ. In IR FR, 35% of the fishes belonged to the size class 19-21 cm, the remaining 75% were equally distributed among the size classes 17-19, 21-23 and >23cm. There was no difference in length between the protected and the unprotected area (Table 3) and no mature *O. chrysurus* was caught during the trap

experimental fishing (Table 4). The length-frequency distribution of *Lutjanus synagris* presented the same profile whatever the location and the protection status. No difference in the length was found between FR and FZ in IR but also in BR (Table 3). The mean length of *L. synagris* caught was higher than the size at maturity (Table 4). 70% of *Cephalopholis fulva* caught in IR FZ belonged to the lowest size class whereas fishes caught in IR FR were distributed in all the size classes with larger fishes contributing to 33% of *C. fulva* catches. As a result, the length was higher inside the IR protected area (Table 3). All *C. fulva* fished inside and outside IR protected area were mature (Table 4).

## **Discussion**

An expected effect of protection is an increase of mean length over time and a higher mean length of target species within the protected areas (Bohnsack, 1998; Halpern et Warner, 2002). Our data indicate that larger fishes were caught inside than outside both fishery reserves. *A. bahianus* and *A. chirurgus* reacted positively to protection in both fishery reserves. A experimental trap fishing survey in Barbados by Rakitin and Kramer (1996) showed a higher mean length of *A. bahianus* inside than outside the Barbados Marine Reserve. These results contrasted with those obtained by Robertson et al. (2005) suggesting that length of *A. bahianus* was not related to fishing pressure but better to temperature and habitat. But the authors have pointed out that detecting the fishing effects on rapid growth and short-lived species like this one requires comparisons between inside and outside protected areas. Lower mean length of *A. chirurgus* inside than outside a protected area in Belize was found by Polunin and Roberts (1993). We found that *S. aurofrenatum* was significantly larger inside IR FR like in St Lucia marine reserves (Hawkins et Roberts, 2003) and in Saba protected areas (Polunin et Roberts, 1993) whereas this species exhibited greater size outside the Exuma Cays Land and Sea Park in the Bahamas archipelago (Mumby et al., 2006). In contrast length of *S. chrysopteron* and *S. viride* did not differ between protected and

unprotected areas. A similar result for *S. chrysopterum* was observed in Barbados by Rakitin and Kramer (1996) whereas higher length of *S. viride* inside protected areas was reported in St Lucia (Hawkins et Roberts, 2003), Belize (Polunin et Roberts, 1993) and Barbados (Rakitin et Kramer, 1996). Greater mean length inside the fishery reserves was also observed for *M. martinicus*, *H. rufus* and *C. fulva* but not for *H. flavolineatum*, *O. chrysurus* and *L. synagris*. This absence of protection positive effect on species, though heavily exploited, was reported in several previous studies (Wantiez et al., 1997; Denny et Babcock, 2004; Ashworth et Ormond, 2005). A possible explanation is that the detection of protection effect is more difficult for these mobile species, especially for larger fishes which are more susceptible to move beyond protected areas boundaries. However, all species except *S. chrysopterum* and *H. flavolineatum* exhibited a greater maximum length inside both fishery reserve (Table 3) and largest size classes were more represented inside protected areas for most species. Our results support the hypothesis that marine protected areas are important for the preservation and the enhance of fish stocks, as fecundity increase with fish size and larger females produce larger eggs and larvae with a better survival potential (Birkeland et Dayton, 2005; Evans et al., 2008).

In addition, the examination of fish gonads revealed that many fishes caught were immature especially Acanthuridae and particularly in the fishing zones. Several studies have demonstrated that trap fishing causes severe growth over-fishing, i.e. premature removal of fish, jeopardizing productivity because of the small trap mesh size (Garrison et al., 2004; Hawkins et al., 2007). Our results provide further evidence that marine reserves are crucial for the sustainability of resources but also that complementary management measures are required through a regulation of trap mesh size. Indeed, overfishing occurred in Caribbean have been attributed among others to trap mesh size used (Mahon et Hunte, 2001).

A limitation of the present study and of many studies investigating protection effects is the lack of baseline data, of before/after comparisons. Nevertheless, this lack of temporal replicates was offset by the survey of two fisheries reserves with different characteristics and which both strongly impacted target species. In a previous length distribution survey of demersal catches in Martinique in 1987, Gobert (1994) showed that martinican fishery is based on small and medium-sized fishes and that the length of most fishes caught ranged from 15 to 20 cm. Similar results were found in the present study except in BR FZ where most fishes caught exhibited a length ranging from 11 to 15 cm (Fig. 3). Gobert (1998) observed length-frequency distribution of *A. bahianus*, *S. aurofrenatum* and *H. rufus* caught in traps set in Martinique. In comparison, the length-frequency distribution of these species obtained in the present study showed a dominance of greater size classes in the fishery reserves. Our findings suggest that the length of these target species has potentially increased after the establishment of the fishery reserves.

Our study highlight that fishery reserves are efficient for protecting overexploited fish stocks but also that this efficiency should be improved by a regulation of trap mesh size used in the surrounding fishing zones. Examining catch-length structure was a good indicator of protection effects and should be considered as a powerful indicator to measure the demographic evolution of target reef fish populations inside and outside marine reserves for evaluating fisheries benefits.

### **Acknowledgements**

This work was made possible through grants from the Regional Council of Martinique. Technical and logistical supports were provided by the Marine Environment Observatory of Martinique and IFREMER. We also thank the Maritime Administration for the fishing permit to sample in the fishery reserves. The authors are very grateful to the fishermen, Mr. Etna, Mr.

Alphonse Altius and Mr. Louis Belvent for the making of the experimental traps, for their help and patience during the experimental fishing.

## References

- Ashworth J.S. and Ormond R.F.G. (2005) Effects of fishing pressure and trophic group on abundance and spillover across boundaries of a no-take zone. *Biol Conserv* **121**:333-344
- Barrett N.S., Edgar G.J., Buxton C.D. and Haddon M. (2007) Changes in fish assemblages following 10 years of protection in Tasmanian marine protected areas. *J Exp Mar Biol Ecol* **345**:141-157
- Birkeland C. and Dayton P.K. (2005) The importance in fishery management of leaving the big ones. *Trends Ecol Evol* **20**:356-358
- Bohnsack J.A. (1998) Application of marine reserves to reef fisheries management. *Aust J Ecol* **23**:298-304
- Chapman M.R. and Kramer D.L. (1999) Gradients in coral reef fish density and size across the Barbados marine reserve boundary: effects of reserve protection and habitat characteristics. *Mar Ecol Prog Ser* **181**:81-96
- Chiappone M., Sluka R. and Sealey K.S. (2000) Groupers (Pisces: Serranidea) in fished and protected areas of the Florida Keys, Bahamas and northern Caribbean. *Mar Ecol Prog Ser* **198**:261-272
- Claudet J., Pelletier D., Jouvenel J.-Y., Bachet F. and Galzin R. (2006) Assessing the effects of Marine Protected Area (MPA) on a reef fish assemblage in a northwestern Mediterranean Marine Reserve: Identifying community based indicators. *Biol Conserv* **130**:349-369
- DeMartini E.E., Friedlander A.M., Sandin S.A. and Sala E. (2008) Differences in fish-assemblage structure between fished and unfished atolls in the northern Line Islands, central Pacific. *Mar Ecol Prog Ser* **365**:199-215
- Denny C.M. and Babcock R.C. (2004) Do partial marine reserves protect reef fish assemblages? *Biol Conserv* **116**:119-129
- Denny C.M., Willis T.J. and Babcock R.C. (2004) Rapid recolonisation of snapper *Pagrus auratus*: Sparidae within an offshore island marine reserve after implementation of no-take status. *Mar Ecol Prog Ser* **272**:183-190

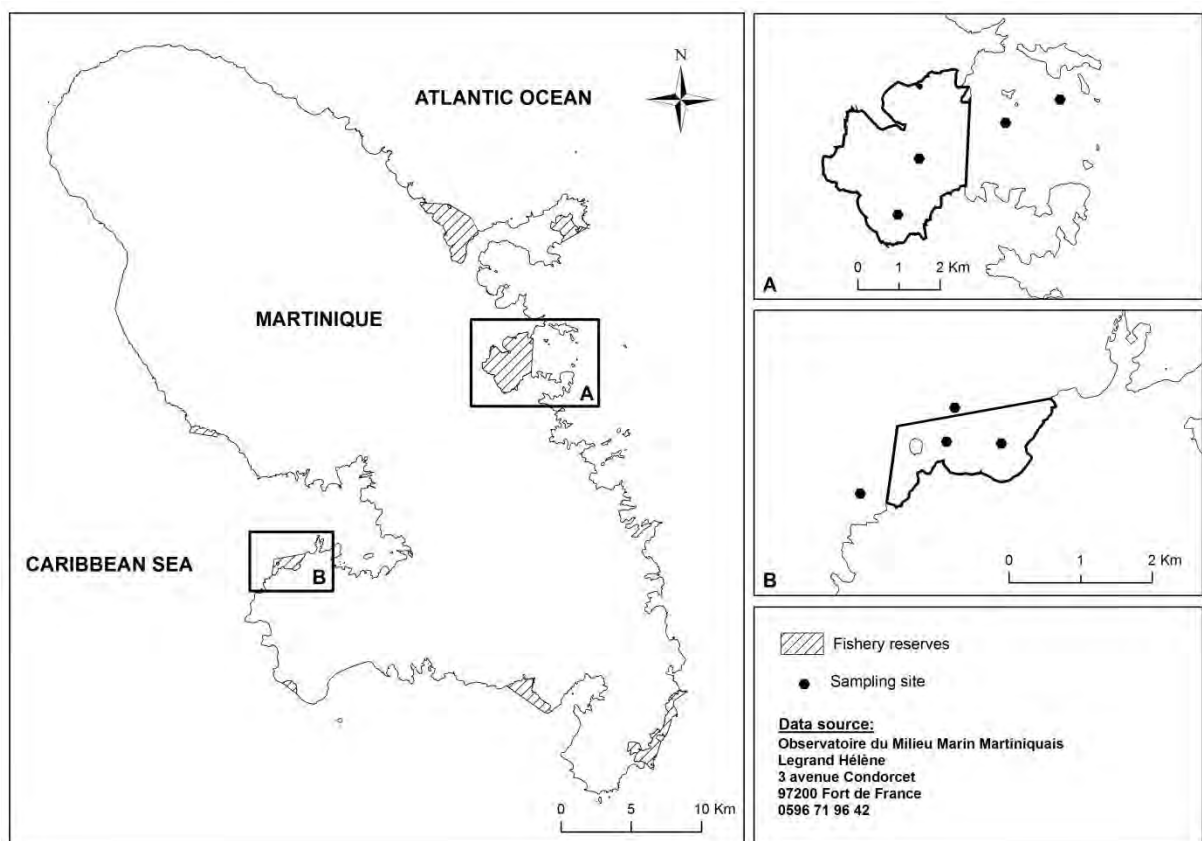
- Dulvy N.K., Polunin N.V.C., Mill A.C. and Graham N.A.J. (2004) Size structural change in lightly exploited coral reef fish communities: evidence for weak indirect effects. *Can J Fish Aquat Sci* **61**:466-475
- Evans R.D., Russ G.R. and Kritzer J.P. (2008) Batch fecundity of *Lutjanus carponotatus* (Lutjanidae) and implications of no-take marine reserves. *Coral Reefs* **27**:179-189
- Floeter S.R., Halpern B.J. and Ferreira C.E.L. (2006) Effects of fishing and protection on Brazilian reef fishes. *Biol Conserv* **128**:391-402
- Garrison V.H., Rogers C.S., Beets J.P. and Friedlander A.M. (2004) The habitats exploited and the species trapped in a Caribbean island trap fishery. *Environ Biol Fishes* **71**:247-260
- Gislason H. and Rice J. (1998) Modelling the response of size and diversity spectra of fish assemblages to changes in exploitation. *ICES J Mar Sci* **55**:362-370
- Gobert B. (1998) Density - dependent size selectivity in Antillean fish traps. *Fish Res* **38**:159-167
- Gobert B. (1990) Production relative des pêcheries côtières en Martinique. *Aquat Living Resour* **3**:181-191
- Gobert B. (1994) Size structure of demersal catches in a multispecies multigear tropical fishery. *Fish Res* **19**:87-104
- Graham N.A.J., Dulvy N.K., Jennings S. and Polunin N.V.C. (2005) Size-spectra as indicators of the effects of fishing on coral reef fish assemblages. *Coral Reefs* **24**:118-124
- Halpern B.J. and Warner R.R. (2002) Marine reserves have rapid and lasting effects. *Ecol Lett* **5**:361-366
- Hawkins J.P. and Roberts C.M. (2004) Effects of artisanal fishing on caribbean coral reefs. *Conserv Biol* **18**:215-226
- Hawkins J.P. and Roberts C.M. (2003) Effects of fishing on sex-changing Caribbean parrotfishes. *Biol Conserv* **115**:213-226
- Hawkins J.P., Roberts C.M., Gell F.R. and Dytham C. (2007) Effects of trap fishing on reef fish communities. *Aquatic Conservation: Marine and Freshwater Ecosystems* **17**:111-132
- Jackson J.B.C., Kirby M.X., Berger W.H., Bjorndal K.A., Botsford L.W., Bourque B.J., Bradbury R.H., Cooke R., Erlandson J., Estes J.A., Hughes T.P., Kidwell S., Lange C.B., Lenihan H.S., Pandolfi J.M., Peterson C.H., Steneck R.S., Tegner M.J. and

- Warner R.R. (2001) Historical overfishing and the recent collapse of coastal ecosystems. *Science* **293**:629-638
- Jennings S., Grandcourt E.M. and Polunin N.V.C. (1995) The effects of fishing on the diversity, biomass and trophic structure of Seychelles' reef fish communities. *Coral Reefs* **14**:225-235
- Jennings S., Greenstreet S.P.R. and Reynolds J.D. (1999) Structural change in an exploited fish community: a consequence of differential fishing effects on species with contrasting life histories. *J Anim Ecol* **68**:617-627
- Mahon R. and Hunte W. (2001) Trap mesh selectivity and the management of reef fishes. *Fish Fish* **2**:356-375
- McClanahan T.R. and Kaunda - Arara B. (1996) Fishery recovery in a coral-reef Marine Park and its effect on the adjacent fishery. *Conserv Biol* **10**:1187-1199
- Mumby P.J., Dahlgren C.P., Harborne A.R., Kappel C.V., Micheli F., Brumbaugh D.R., Holmes K.E., Mendes J.M., Broad K., Sanchirico J.N., Buch K., Box S., Stoffle R.W. and Gill A.B. (2006) Fishing, trophic cascades, and the process of grazing on coral reefs. *Science* **311**:98-101
- Nguyen L.V. and Phan H.K. (2008) Distribution and factors influencing on structure of reef fish communities in Nha Trang Bay Marine Protected Area, South-Central Vietnam. *Environ Biol Fishes* **82**:309-324
- Pauly D., Christensen V., Gu nette S., Pitcher T.J., Sumaila U.R., Walters C.J., Watson R. and Zeller D. (2002) Towards sustainability in world fisheries. *Nature* **418**:689-695
- Pauly D. and Watson R. (2005) Background and interpretation of "Marine Trophic Index" as a measure of diversity. *Philos Trans R Soc Lond B Biol Sci* **360**:415-423
- Polunin V.C. and Roberts C.M. (1993) Greater biomass and value of target species coral reef fishes in two small Caribbean marine reserves. *Mar Ecol Prog Ser* **100**:167-176
- Pope J.G., Sheperd J.G. and Webb J. (1994) Successful surfriding on size spectra: the secret of survival in the sea. *Philos Trans R Soc Lond B Biol Sci* **343**:41-49
- Rakitin A. and Kramer D.L. (1996) Effect of a marine reserve on the distribution of coral reef fishes in Barbados. *Mar Ecol Prog Ser* **131**:97-113
- Roberts C.M., Bohnsack J.A., Gell F.R., Hawkins J.P. and Goodridge R. (2001) Effects of marine reserves on adjacent fisheries. *Science* **294**:1920-1923
- Robertson D.R., Choat J.H., Posada J.M., Pitt J. and Ackerman J.L. (2005) Ocean surgeonfish *Acanthurus bahianus*. II. Fishing effects on longevity, size, abundance. *Mar Ecol Prog Ser* **295**:245-256

Tuya F., Ortega-Borges L., Sanchez-Jerez P. and Haroum R.J. (2006) Effect of fishing pressure on the spatio-temporal variability of the parrotfish, *Sparisoma cretense* (Pisces: Scaridae), across the Canarian Archipelago (eastern Atlantic). *Fish Res* **77**:24-33

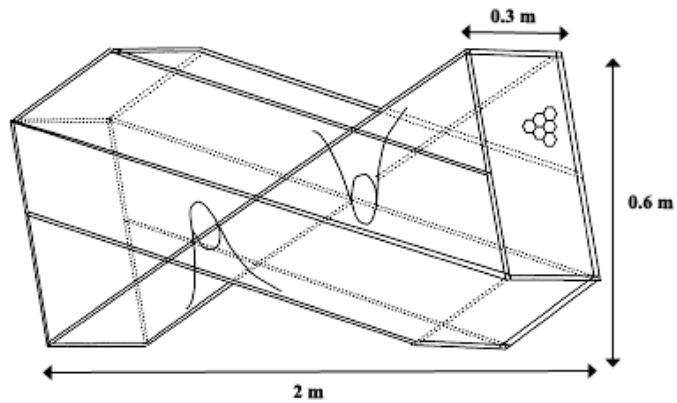
Wantiez L., Thollot P. and Kulbicki M. (1997) Effects of marine reserves on coral reef fish communities from five islands in New Caledonia. *Coral Reefs* **16**:215-224

## Figures

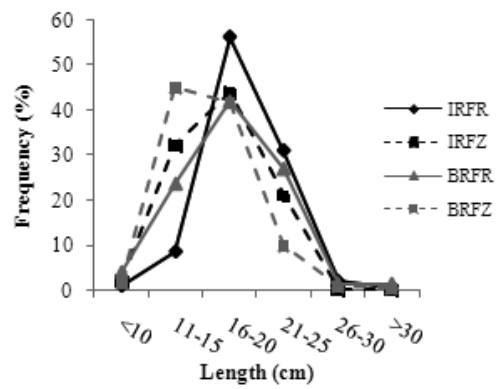


**Figure 1.** Map of the network of protected areas in Martinique showing the studied fishery reserves (A: Baie du Robert B: Ilet à Ramier) and the sampling sites.





**Figure 2.** The double-funnel Antillean-Z trap (from Mahon and Hunte 2001).



**Figure 3.** Length-frequency distribution of overall catch in Ilet à Ramier fishery reserve (IRFR) and fishing zone (IRFZ) and in Baie du Robert fishery reserve (BRFR) and fishing zone (BRFZ).

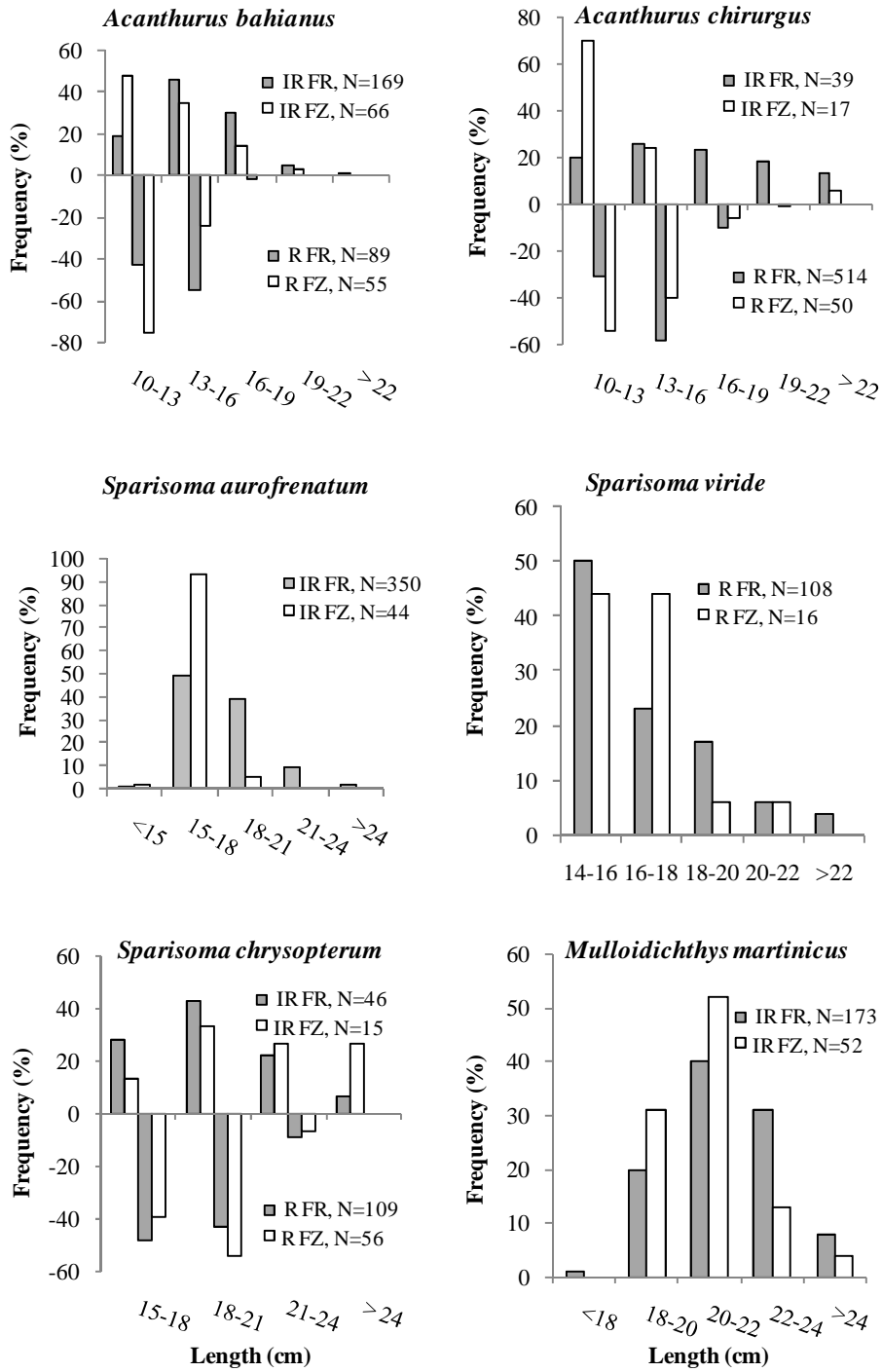
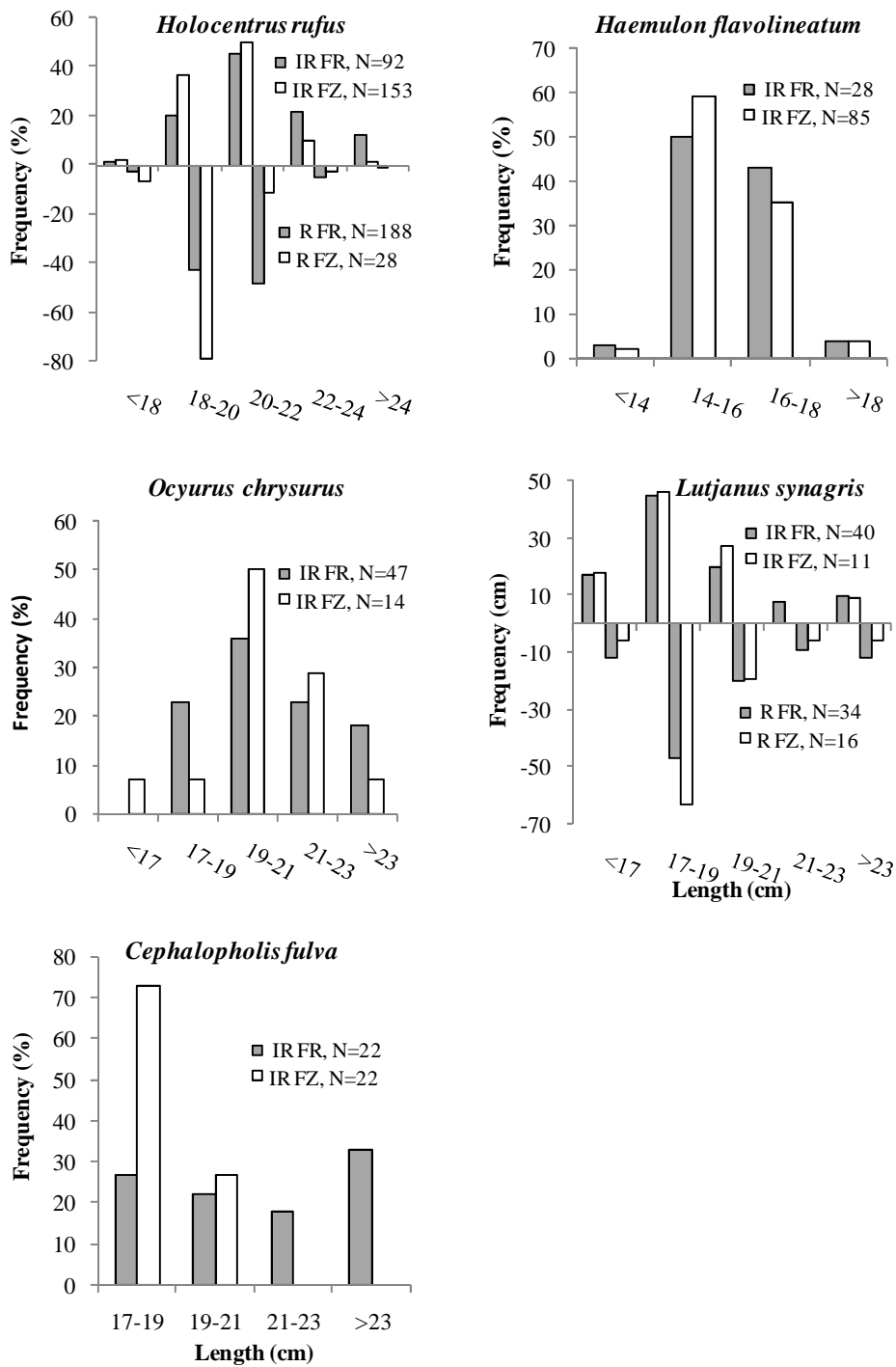


Figure 4 (continued)



**Figure 4.** Length-frequency distribution of *Acanthurus bahianus*, *A. chirurgus*, *Sparisoma aurofrenatum*, *S. chrysopterus*, *S. viride*, *Mulloidichthys martinicus*, *Holocentrus rufus*, *Haemulon flavolineatum*, *Ocyurus chrysurus*, *Lutjanus synagris* and *Cephalopholis fulva* inside and outside the fishery reserves.

## Tables

**Table 1**

Fishery reserve	Location	Year of establishment	Size (ha)
Ilet à Ramier	Caribbean Sea (west coast)	1999	184
Baie du Robert	Atlantic Ocean (east coast)	2000	983

Table 1. Main characteristics of the studied fishery reserves.

**Table 2**

Ilet à Ramier		Baie du Robert	
FR	FZ	FR	FZ
Species (49)	%	Species (29)	%
<i>Acanthurus bahianus</i>	10.6	<i>Acanthurus chirurgus</i>	2
<i>Acanthurus chirurgus</i>	2.5	<i>Sparisoma aurofrenatum</i>	5.3
<i>Acanthurus coeruleus</i>	1.3	<i>Sparisoma chrysopterum</i>	1.8
<i>Sparisoma aurofrenatum</i>	22.1	<i>Scarus taeniopterus</i>	3.3
<i>Sparisoma chrysopterum</i>	2.9	<i>Lutjanus synagris</i>	1.3
<i>Sparisoma viride</i>	1.2	<i>Ocyurus chrysurus</i>	1.7
<i>Scarus iseri</i>	6.2	<i>Haemulon flavolineatum</i>	10.1
<i>Lutjanus synagris</i>	2.5	<i>Haemulon chrysargyreum</i>	1.2
<i>Ocyurus chrysurus</i>	3	<i>Haemulon aurolineatum</i>	1.2
<i>Haemulon flavolineatum</i>	1.6	<i>Cephalopholis fulva</i>	2.6
<i>Haemulon chrysargyreum</i>	2.3	<i>Epinephelus guttatus</i>	1.6
<i>Cephalopholis fulva</i>	1.4	<i>Holocentrus rufus</i>	18.3
<i>Holocentrus rufus</i>	5.8	<i>Holocentrus adscensionis</i>	1.7
<i>Holocentrus adscensionis</i>	3	<i>Myripristis jacobus</i>	12.9
<i>Myripristis jacobus</i>	2.6	<i>Mulloidichthys martinicus</i>	6.2
<i>Mulloidichthys jacobus</i>	2.6	<i>Pseudupeneus maculatus</i>	3.3
<i>Pseudupeneus maculatus</i>	7	<i>Chaetodon striatus</i>	1.3
<i>Eucinostomus gula</i>	1		
<i>Caranx latus</i>	2.5		
<i>Cantherhines pullus</i>	9.3		
<i>Chaetodon striatus</i>			
<i>Chaetodon capistratus</i>			

Table 2. Species composition (species representing 1% and more than 1% of total catch) of overall catches (number of fishes caught) inside and outside Ilet à Ramier and Baie du Robert fishery reserves. The number of species caught for each location is noticed in brackets.

**Table 3**

	Ilet à Ramier			Baie du Robert		
	FR	FZ	p	FR	FZ	p
<i>Acanthurus bahianus</i>						
Minimum	11	10.5		11	11	
Maximum	23.5	20.5		17	15	
Mean	15.56 (0.18)	12.48 (0.14)	<0.001	13.65 (0.23)	11.48 (0.14)	<0.001
<i>Acanthurus chirurgus</i>						
Minimum	10	10.5		10	10	
Maximum	23	23		22	18.5	
Mean	17.12 (0.59)	12.79 (0.71)	<0.001	14.17 (0.08)	12.22 (0.28)	<0.001
<i>Sparisoma aurofrenatum</i>						
Minimum	13.5	14.5		-	-	
Maximum	25	19		-	-	
Mean	18.65 (0.12)	16.41 (0.17)	<0.001	-	-	-
<i>Sparisoma viride</i>						
Minimum	-	-		14	15	
Maximum	-	-		26.5	21	
Mean	-	-	-	17.15 (0.22)	16.78 (0.38)	0.849
<i>Sparisoma chrysopterum</i>						
Minimum	16	16		15	16	
Maximum	26	29		23	23	
Mean	19.89 (0.36)	21.6 (0.95)	0.058	18.66 (0.16)	18.62 (0.21)	0.808
<i>Mulloidichthys martinicus</i>						
Minimum	17	18		-	-	
Maximum	29	26.5		-	-	
Mean	21.88 (0.14)	20.09 (0.23)	0.005	-	-	-
<i>Holocentrus rufus</i>						
Minimum	14.5	15		17	16.5	
Maximum	28.5	24.5		24.5	22.5	
Mean	21.67 (0.23)	20.71 (0.1)	<0.001	20.42 (0.1)	19.25 (0.24)	<0.001
<i>Haemulon flavolineatum</i>						
Minimum	12	13		-	-	
Maximum	19	19		-	-	
Mean	16.34 (0.28)	16.01 (0.14)	0.086	-	-	-

<i>Ocyurus chrysurus</i>						
Minimum	17	20.5		-	-	
Maximum	25.5	24		-	-	
Mean	20.93 (0.29)	20.14 (0.85)	0.721	-	-	
<i>Lutjanus synagris</i>						
Minimum	15.5	15.5		15	16	
Maximum	26	23.5		32.5	25	
Mean	19.15 (0.45)	18.59 (0.7)	0.737	19.49 (0.58)	18.87 (0.55)	0.650
<i>Cephalopholis fulva</i>						
Minimum	17.5	17		-	-	
Maximum	27	21		-	-	
Mean	21.59 (0.59)	18.88 (0.2)	<0.001	-	-	-

**Table 3.** Minimum, maximum and mean length (cm), with standard deviation in brackets, of the more common species caught in traps inside (FR) and outside (FZ) the fishery reserves with results of Mann-Whitney test comparing differences between FR and FR.

Table 4

	Size at first maturity from the present study	Size at maturity first from other sources
<i>Acanthurus bahianus</i>	14	14 <sup>a</sup> 11 <sup>b</sup>
<i>Acanthurus chirurgus</i>	16	17 <sup>b</sup>
<i>Sparisoma aurofrenatum</i>	14.5 (IP) and 16 (TP)	14 <sup>a</sup> 14 (IP) and 15 (TP) <sup>b</sup>
<i>Sparisoma viride</i>	None mature fish was caught	25 (TP) <sup>a</sup> 20 (TP) <sup>b</sup>
<i>Sparisoma chrysopterum</i>	IP : 16 None mature TP was caught	Not available neither from <sup>a</sup> nor from <sup>b</sup>
<i>Mulloidichthys martinicus</i>	Not established	20 <sup>a</sup> 18 <sup>b</sup>
<i>Holocentrus rufus</i>	Not established	13 <sup>a</sup> 13-14 <sup>b</sup>
<i>Haemulon flavolineatum</i>	Cannot be established	15 <sup>a</sup> 15 <sup>b</sup>
<i>Ocyurus chrysurus</i>	None mature fish was caught	32 <sup>a</sup> > 26 <sup>b</sup>
<i>Lutjanus synagris</i>	18	18 <sup>b</sup>
<i>Cephalopholis fulva</i>	17	19 <sup>a</sup> Probably at or before 16 <sup>b</sup>

**Table 4.** Size (cm) at first maturity of target species established from the present data set, and by <sup>a</sup> Hawkins et al. (2007) in St-Lucia and <sup>b</sup> Munro (1983) in Jamaica from fishes caught in traps. TP and IP are terminal phase and initial phase, respectively.



**CHAPITRE V**  
**Age and growth of the Caribbean redband  
parrotfish *Sparisoma aurofrenatum* inside and  
outside a protected area**

# Age and growth of the Caribbean redband parrotfish *Sparisoma aurofrenatum* inside and outside a protected area

(manuscript in preparation)

Géraldine CRIQUET<sup>a\*</sup>, Jessica GARCIA<sup>a</sup>, Jean-Philippe MARECHAL<sup>b</sup>, Lionel REYNAL<sup>c</sup>,  
Philippe LENFANT<sup>a</sup>

<sup>a</sup>UMR 5244 CNRS-EPHE-UPVD Center of Tropical and Mediterranean Biology and Ecology, 52 Avenue Paul Alduy Perpignan University 66860 Perpignan Cedex France

<sup>b</sup>Marine Environment Observatory of Martinique, 3 Avenue Condorcet 97200 Fort-de-France Martinique France

<sup>c</sup>IFREMER Robert Station Pointe Fort 97231 Le Robert Martinique France

## INTRODUCTION

The redband parrotfish *Sparisoma aurofrenatum* is a common herbivore on Caribbean coral reefs. Several studies highlight that parrotfishes play an essential role in coral reefs conservation by limiting algal proliferation through their grazing activities (Mumby et al., 2006; Mumby, 2009). Most of Caribbean herbivorous communities undergo a high fishing pressure and a decrease of mean size and abundance of Scaridae was related with the intensity of exploitation (Koslow et al., 1988; Hawkins et Roberts, 2004). Growth is an important factor in the life history of fishes that need to be known for stocks management. There is an evident lack of age-based studies of reef fishes in the Caribbean. Published data on Scaridae growth are particularly scarce. A number of studies have reported variation in growth in Scaridae due to habitat (Choat et al., 2003) and sexual identity (van Rooij et al., 1995). But most studies focalized on the largest species *Sparisoma viride* and *Scarus vetula* (Bruggemann et al., 1994b; Bruggemann et al., 1994c).

Several authors have reported for Scaridae benefits from marine protected areas such as greater abundances and mean size (Polunin et Roberts, 1993; Floeter et al., 2006; Hawkins et al., 2006).

The objective of the present study was to examine the growth patterns of *Sparisoma aurofrenatum* inside and outside a Caribbean marine reserve with the prediction that maximum age is greater inside the protected area.

## **MATERIALS AND METHODS**

### **Study site and data collection**

Unbaited double funnel Antillean-Z traps (2x0.6x0.3 m mesh-sized of 31 mm) were used for the experimental fishing campaigns. Traps are the most common fishing gear used in the Caribbean Region (Gobert, 1998) and produce approximately 70% of the benthic catches in Martinique (Gobert, 1990). Traps fishing campaigns were conducted inside (FR) and outside (FZ) the Ilet a Ramier fishery reserve (Fig 1 (A)), located on the leeward coast of Martinique, during the dry (March and April) and the wet (September and October) seasons in 2007.

### **Otolith processing**

All individual were measured (total length, cm) and weighed to the nearest gram. Sagittae were removed, cleaned and store dried. One sagitta of each pair was weighed to the nearest 0.0001 g before having mounted in the thermoplastic cement CrytalBond on a slide edge and ground down to the nucleus using P1200 and P2400 grit abrasive paper. The opposite side was also ground down to the nucleus. Each otolith was read 3 times by 3 different readers. A previous study has validated the annual nature of the sagitta check marks for the study species (Amilhat, 1999) and others studies have validated the daily rings for others species of parrotfishes (Lou et Moltschaniwskyj, 1992; Choat et al., 1996; Choat et al., 2003).

### **Growth analysis**

Face to the very level of catches of terminal phase, growth was estimated only for initial phase (IP). Growth parameters were estimated by fitting the von Bertalanffy growth curve:

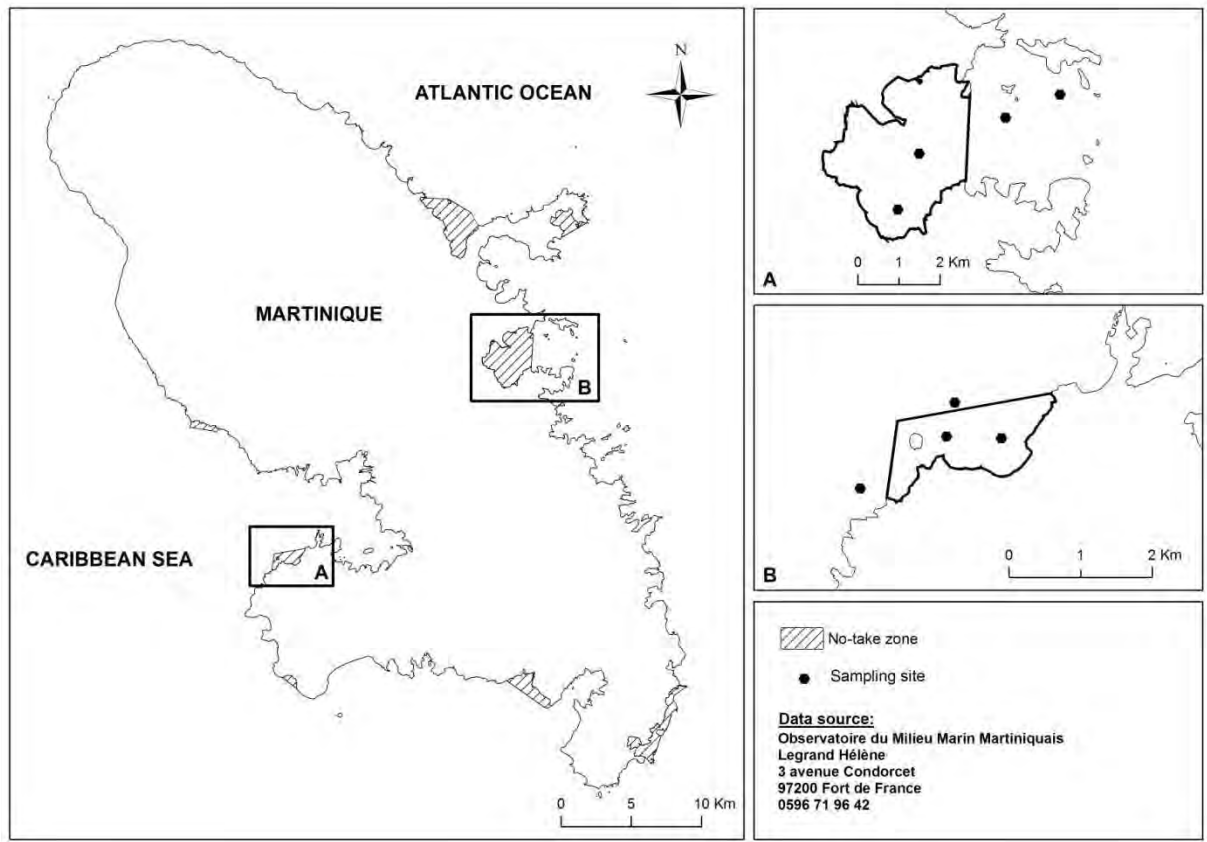
$L_t = L_\infty \times \left(1 - \exp(-K(t-t_0))\right)$  where  $L_t$  is the estimated length at age  $t$ ,  $L_\infty$  is the asymptotic length,  $K$  is the curvature parameter and  $t_0$  is the age at which fish have theoretical length of 0. We have also calculated the Fulton condition factor  $K = \frac{P}{L^3}$ . We compared  $K$  and

mean length at age between inside and outside the protected area using the Mann-Whitney test and age-frequency distribution with the Kolmogorov-Smirnov test.

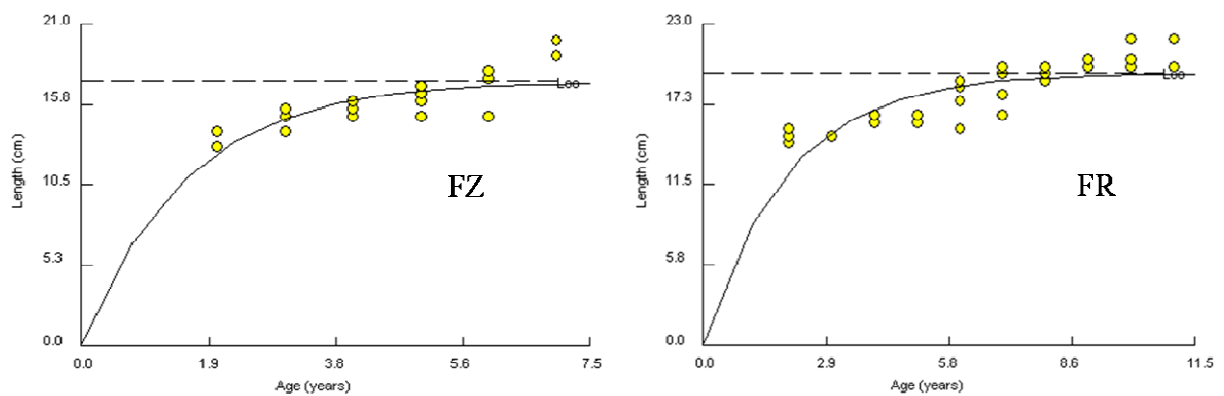
## **RESULTS AND DISCUSSION**

The growth of IP of *Sparisoma aurofrenatum* showed a different pattern between inside and outside the protected area (Fig. 2). Fishes growth faster outside the protected area but the asymptotic length was higher inside the protected area although this difference was not significant ( $p>0.05$ ) (Table 1). A greater size at a given age was achieved inside the protected area especially for the 2 and 6 years old fishes (Table 2). The maximum age reached was 7 and 11 in the protected and unprotected area, respectively (Fig. 3). A similar result was found in a growth study of the stoplight parrotfish *Sparisoma viride* showing a decrease of maximum age with the increase of fishing pressure (Choat et al., 2003). These results support the hypothesis that marine protected areas are important for the maintenance of resources, as older females produce larvae with a better survival potential and a better growth (Birkeland et Dayton, 2005). In addition, the Fulton coefficient was significantly higher inside the fishery reserve inducing a better condition that contributed to higher productivity through a greater fecundity (Rätz et Lloret, 2003) and to higher environmental stresses resistance (Lambert et Dutil, 1997).

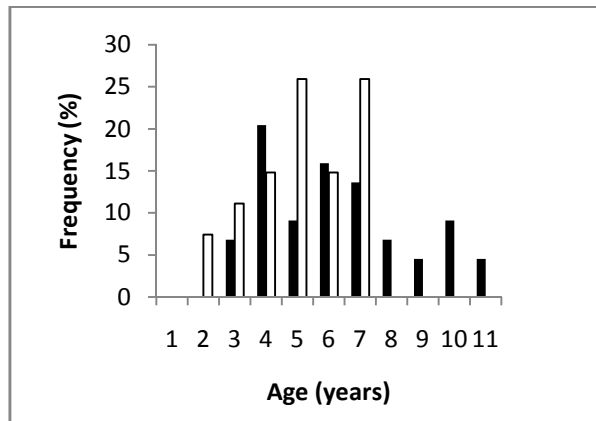
Figures and tables



**Figure 1.** Map of the study area. A is the Ilet à Ramier fishery reserve where fishes were caught.



**Figure 2.** Relation between length and age for *Sparisoma aurofrenatum*. Data are fitted to the von Bertalanffy equation  $L_t = L_{\infty} \times (1 - \exp^{-K(t-t_0)})$ .  $N(\text{FR})=44$  et  $N(\text{FZ})=23$ .



**Figure 3.** Age-frequency distribution of *Sparisoma aurofrenatum* inside (black bars) and outside (white bars) Ilet à Ramier fishery reserve.

**Table 1.** Growth parameters and Fulton coefficient inside (FR) and outside (FZ) the protected area. The difference in Fulton coefficient between inside and outside was significant ( $p=0.05$ ).

	FR	FZ
$L_{\infty}$ (cm)	$19.50 \pm 2.7$	$17.30 \pm 3.2$
K	$0.51 \pm 0.01$	$0.65 \pm 0.01$
Fulton coefficient	$0.019 \pm 10^{-4}$	$0.015 \pm 2.10^{-4}$

**Table 2.** Mean length (cm) at age inside (FR) and outside (FZ) the protected area

Age	FR	FZ	p
2	$15.125 \pm 0.23$	$13.5 \pm 0.2$	0.05
3	15	$14.83 \pm 0.7$	NS
4	$16.11 \pm 0.07$	$15.375 \pm 0.4$	NS
5	$16.375 \pm 0.0125$	$16.357 \pm 0.5$	NS
6	$18.07 \pm 0.05$	$16.375 \pm 1.6$	0.05
7	$18.58 \pm 0.05$	$19.5 \pm 0.7$	NS
8	$19.5 \pm 0.2$		
9	$20.25 \pm 0.25$		
10	$20.75 \pm 0.43$		
11	$21 \pm 0.9$		

## Acknowledgements

This work was made possible through grants from the Regional Council of Martinique. The authors thank the Marine Environment Observatory of Martinique and IFREMER for their technical and logistical supports. We thank Mr. Etna for the making of the experimental traps. We also thank the Maritime Administration for the fishing permit to sample in the fishery reserves. We are very grateful to Mr. Alphonse Altius and Mr. Louis Belvent, the fishermen who helped for the experimental fishing for their great patience and their advices.

## References

- Amilhat E. (1999) Estimation de la durée de vie larvaire et caractérisation de la croissance des Scaridae et Acanthuridae de Discovery Bay, Jamaïque. *Diplôme d'Etudes Supérieures de Sciences Université Pierre et Marie Curie (Paris VI)*:82p
- Bruggemann J.H., Kuyper M.W. and Breeman A.M. (1994a) Comparative analysis of foraging and habitat use by the sympatric Caribbean parrotfish *Scarus vetula* and *Sparisoma viride* (Scaridae). *Mar Ecol Prog Ser* **112**:51-66
- Bruggemann J.H., van Oppen M.J.H. and Breeman A.M. (1994b) Foraging by the stoplight parrotfish *Sparisoma viride*. I. Food selection in different, socially determined habitats. *Mar Ecol Prog Ser* **106**:41-55
- Choat J.H., Axe L.M. and Lou D.C. (1996) Growth and longevity in fishes of the family Scaridae. *Mar Ecol Prog Ser* **145**:33-41
- Choat J.H., Robertson D.R., Ackerman J.L. and Posada J.M. (2003) An age-based demographic analysis of the Caribbean stoplight parrotfish *Sparisoma viride*. *Mar Ecol Prog Ser* **246**:265-277
- Floeter S.R., Halpern B.J. and Ferreira C.E.L. (2006) Effects of fishing and protection on Brazilian reef fishes. *Biol Conserv* **128**:391-402
- Gobert B. (1998) Density - dependent size selectivity in Antillean fish traps. *Fish Res* **38**:159-167
- Gobert B. (1990) Production relative des pêcheries côtières en Martinique. *Aquat Living Resour* **3**:181-191
- Hawkins J.P. and Roberts C.M. (2004) Effects of artisanal fishing on caribbean coral reefs. *Conserv Biol* **18**:215-226

- Hawkins J.P., Roberts C.M., Dytham C., Schelten C. and Nugues M.M. (2006) Effects of habitat characteristics and sedimentation on performance of marine reserves in St. Lucia. *Biol Conserv* **127**:487-499
- Koslow J.A., Hanley F. and Wicklund R. (1988) Effects of fishing on reef fish communities at Pedro Bank and Port Royal Cays, Jamaica. *Mar Ecol Prog Ser* **43**:201-212
- Lou D.C. and Moltschaniwskyj N.A. (1992) Daily otolith increments in juvenile tropical parrotfishes and surgeonfishes. *Aust J Mar Freshw Res* **43**:973-981
- Mumby P.J. (2009) Herbivory versus corallivory: are parrotfish good or bad for Caribbean coral reefs? *Coral Reefs*
- Mumby P.J., Dahlgren C.P., Harborne A.R., Kappel C.V., Micheli F., Brumbaugh D.R., Holmes K.E., Mendes J.M., Broad K., Sanchirico J.N., Buch K., Box S., Stoffle R.W. and Gill A.B. (2006) Fishing, trophic cascades, and the process of grazing on coral reefs. *Science* **311**:98-101
- Polunin V.C. and Roberts C.M. (1993) Greater biomass and value of target species coral reef fishes in two small Caribbean marine reserves. *Mar Ecol Prog Ser* **100**:167-176
- van Rooij J.M., Bruggemann J.H., Videler J.J. and Breman A.M. (1995) Plastic growth of the herbivorous reef fish *Sparisoma viride*: field evidence for a trade-off between growth and reproduction. *Mar Ecol Prog Ser* **122**:93-105



**CHAPITRE VI**

**Discrimination of Caribbean redband  
parrotfish (*Sparisoma aurofrenatum*) from  
protected and unprotected areas using otolith  
shape**

Discrimination of Caribbean redband parrotfish (*Sparisoma aurofrenatum*) from protected and unprotected areas using otolith shape

Géraldine Criquet<sup>a</sup>, Jessica Garcia<sup>a</sup>, Philippe Lenfant<sup>a</sup>, Jean-Philippe Maréchal<sup>b</sup>, Lionel Reynal<sup>c</sup>

(manuscrit in preparation)

<sup>a</sup>UMR 5244 Center of Tropical and Mediterranean Biology and Ecology University of Perpignan Via Domitia 66860 Perpignan France geraldine.criquet@univ-perp.fr; <sup>b</sup>OMMM 3, avenue de Condorcet 97200 Fort-de-France Martinique (FWI);

<sup>c</sup>IFREMER Station du Robert Pointe Fort 97231 Le Robert Martinique (FWI)

Otolith is widely used in the study of stocks identification essential for fisheries management. Scaridae are ecologically important in the Caribbean reef fish fauna and are exploited by traditional fisheries. Sagittal otoliths of the red-band parrotfish *Sparisoma aurofrenatum* were examined in order to analyze geographical and temporal variations of populations. Shape indices (roundness, rectangularity) and Fourier descriptors were compared between fishes caught by traps in 2007 in March (dry season) and October (wet season), between fishes from Caribbean and Atlantic sites and between protected and unprotected areas within sites. Temporal and spatial differences both site-specific and level of protection-specific were found. Canonical discriminant analysis based on Fourier descriptors indicated a strong discrimination of *Sparisoma aurofrenatum* populations: 1) between dry and wet seasons, 2) between Atlantic and Caribbean sites and 3) between protected and unprotected areas, with high classification rates. The observed differences in otolith shape may result of environmental effects like stress, type and quality of habitat inducing differences in food quality and quantity. The combination of shape indices and external outline analysis showed that otolith shape is a powerful indicator for population discrimination.

Key words: Otolith shape, *Sparisoma aurofrenatum*, Martinique

## **Introduction**

Parrotfishes (family Scaridae) are very important in coral reef ecosystems in ecological and economical point of view. Scaridae represent one of the two families of herbivorous species in the Caribbean. They play an important role in the transfer of energy from primary producers to the higher trophic levels (Bruggemann et al., 1994a) and take part in coral reefs conservation through the grazing activities. The red band parrotfish *Sparisoma aurofrenatum* is widely distributed in Caribbean coral reefs ecosystems and is a significant component of traps catches in Martinique. According to (Gobert, 1990), traps produce around 60% of benthic catches and Scaridae represent around 14% of total benthic catches in Martinique. Despite the ecological and economical importance of Scaridae, few biological and ecological data on Caribbean parrotfishes are available while informations on population structure and stock discrimination are essential for fishery management.

Otolith analysis is an important tool to study fish populations and recent studies used with success shape analysis of otolith to distinguish groups of fish (DeVries et al., 2002; Petursdottir et al., 2006; Pothin et al., 2006; Tracey et al., 2006; Burke et al., 2008). Otoliths, small calcified structures located in fish ear, are natural “black box” that record information in their microstructure and chemistry (Campana, 1999). This information, including growth, feeding, habitat, can be used at the population level in terms of ecology, demography and life history of species essential in fisheries management and species protection (Popper et al., 2005). Otolith shape is species specific (L'Abée-Lund, 1988) and often varies geographically within species in relation to environmental factors. Variation in otolith shape is widely considered as a useful descriptor to identify and discriminate fish stocks (Campana et Casselman, 1993; Katayama et Isshiki, 2007; Stansky et al., 2007).

This study investigates if *Sparisoma aurofrenatum* captured at different sites and season around Martinique can be distinguished on the basis of otolith shape.

## **Materials and methods**

### **Fish sampling**

Martinique is located in Lesser Antilles in South of the Caribbean island arc. This is a volcanic island characterized by mountainous relief and narrow shelves. Unbaited double funnel Antillean-Z traps were used for experimental fishing: 2 x 0.6 x 0.3 m with a mesh size of 31 mm. Trap fishing was conducting in March (dry season) and October (wet season) 2007

and sites were selected on Caribbean and Atlantic coast both in unprotected (FZ) and protected areas (NTZ) (Fig. 1).

#### Laboratory procedures

Following sampling, each fish was measured (total and standard length in cm) and weighed (total weight in g). Pairs of sagittae were removed, cleaned with distilled water, dried and stored in tubes. Each otolith was weighed to the nearest  $10^{-2}$  mg. Otolith size variables, length ( $L_o$ ), width ( $l_o$ ), perimeter ( $P_o$ ) and area ( $A_o$ ) were obtained by an image analysis software (Visilog 6.2. Noesis).

Otolith shape indices. Shape indices result from different combinations of size variables (Tuset et al., 2003a) (Table 1.). In this study, we focused on roundness and rectangularity. Roundness give information on the similarity of various features to a perfect circle and rectangularity describes the variations of length and width with respect to the area.

#### Otolith shape analysis

The method of elliptic Fourier descriptors was used in accordance with the procedures suggested by (Kuhl et Giardina, 1982). Fourier descriptors have been successfully used for the characterization of closed contours. Normalized elliptic Fourier descriptors were calculated with Shape software (Iwata et Ukai, 2002). The Fourier analysis indicated that *Sparisoma aurofrenatum* otolith shape could be summarized by 20 harmonics.

#### Data analysis

First otolith morphometric variables of left and right otoliths were compared pair-wise using t-test. No difference was found therefore analysis was performed on otolith from the two sides. All variables were examined for normality (Kolmogorov-Smirnov's test) and homogeneity (Bartlett's test) of variances. Total length of fishes was compared between March and October (temporal level) and between unprotected and protected areas both for Atlantic and Caribbean side (spatial level) for Initial phase (IP) and Terminal phase (TP) using Mann-Whitney non parametric test. Shape indices were compared to determine differences between season and sites. Canonical discriminant analysis (CDA) were performed on Fourier coefficients defining the 20 harmonics to determine spatial (site and protection) and temporal (season) variation of otolith shape. Previously, we have verified that there is no discrimination between IP and TP based on otolith shape.

## Results

### Population structure

In March and October IP catches dominated (Fig. 2). Length of IP showed different distribution between seasons (Fig. 3 and 4), there was no difference of length distribution between season in the case of TP (Fig. 5 and 6). Length of IP was significantly higher in March ( $P=0.003$ ) but TP length was not different between season ( $P>0.005$ ). On Caribbean coast, IP catches were higher both in NTZ and FZ (Fig.7). Length of both phases showed a different distribution between NTZ and FZ (Fig. 8, 9, 10 and 11) and was significantly higher in NTZ than in FZ ( $P<0.001$ ). On the opposite, in case of Atlantic coast, TP catches were higher in NTZ and equal to IP catches in FZ (Fig. 12). Length distribution of both phases was similar between protected and unprotected areas (Fig. 13, 14, 15 and 16) and length was not different between areas with different level of protection ( $P>0.005$ ).

### Otolith shape indices

Roundness and rectangularity of different season, sites and level of protection are summarized in Table. 2. Roundness was similar between seasons but was higher for FZ than for NTZ both for Caribbean and Atlantic coast. Rectangularity was equal between seasons, sites and level of protection.

### Fourier shape analysis

Fig. 17, 18 and 19 show CDAs performed on Fourier descriptors of otolith of *Sparisoma aurofrenatum* from different seasons, sites and level of protection. CDAs gave a classification success of 80% indicating a strong separation between seasons, sites and protected and unprotected areas. The F test associated to Wilk's lambda was highly significant ( $P<0.001$ ) and 100% of individuals were correctly classified. The estimate of Cohen's kappa confirmed the high rates of classification success

## Discussion

Otolith shape analysis was used to distinguish between March and October (temporal scale) fishing *Sparisoma aurofrenatum* from different sites and level of protection (spatial scale). The results of this study showed that a spatio-temporal variability of red-band parrotfish otolith occurred. Several confounding effects must be considered. Indeed sex, age and fish size may influence otolith shape (Campana et Casselman, 1993). We have taken both initial

and terminal phase but we have previously tested that there is no difference in otolith shape between those phases. In this study, fish length showed different distribution between seasons, site and level of protection but length was not significantly different except between NTZ and FZ for Caribbean coast and between seasons for IP. But according to (Gagliano et McCormick, 2004), shape difference could not be attributed to size difference among fish and suggest that shape may reflect fish condition. Differences were observed in roundness at sites and level of protection, but rectangularity was equal between seasons, sites and level of protection. Pothin et al. (2006) found differences in all shape indices considered for sites intra-island (Reunion) and sites inter-island (Reunion and Mauritius).

CDA performed on Fourier descriptors indicated a clear discrimination in otolith shape between seasons, sites and level of protection with a rate of accuracy in classification that reached 80%. Different results were found in the literature. Devries et al. (2002) obtained about 81.6% accuracy to differentiate stocks of *Scomberomus cavalla* between the Eastern Gul of Mexico and Atlantic Ocean. (Gonzales-Salas et Lenfant, 2007) showed that temporal difference of *Engraulis encrasicolus* occurred between years in the Gulf of Biscay with an accuracy >80. Burke et al. (2008) obtained about 84% accuracy for discriminate *Clupea harengus* from Celtic and Irish Seas. Thus, analysis of sagittal shape using Fourier descriptors is a powerful indicator for showing temporal and spatial differences. Campana & Casselman (1993) suggested that environmental factors are generally more influential determinants of otolith shapes than genetic. Differences in otolith shape in this study occurred between groups of fish that are close or very close geographically: island scale (Caribbean and Atlantic coast) and protection scale (NTZ and FZ). It is probable that those differences are driven by environmental factors. Spatial and temporal variations of otolith shape in this study could derived from environmental variations as stress, differences in type and quality of habitat inducing differences in food quality and quantity inducing differences in fish condition and growth rates. Other tools as otolith chemistry and tagging could be useful in order to follow the dynamic of *Sparisoma aurofrenatum* stocks.

### **Acknowledgements**

We thank the Regional Council of Martinique for the financial support and IFREMER and Observatoire du Milieu Marin Martiniquais for the technical support. We are grateful to the fishermen who work with us on the field.

## REFERENCES

- Bruggemann J. H., Begeman J., Bosma E. M., Verburg P., Breeman A. M. (1994) Foraging by the stoplight parrotfish *Sparisoma viride*. II. Intake and assimilation of food, protein and energy. *Marine Ecology Progress Series* 106:57-71
- Burke N., Brophy D., King P. A. (2008) Shape analysis of otolith annuli in Atlantic herring (*Clupea harengus*); a new method for tracking fish populations. *Fisheries Research* 91:133-143
- Campana S. E. (1999) Chemistry and composition of fish otoliths: pathways, mechanisms and applications. *Marine Ecology Progress Series* 188:263-297
- Campana S. E., Casselman J. M. (1993) Stock discrimination using otolith shape analysis. *Canadian Journal of Fisheries and Aquatic Sciences* 50:1062-1083
- DeVries D. A., Grimes C. B., Prager M. H. (2002) Using otolith shape analysis to distinguish eastern Gulf of Mexico and Atlantic Ocean stocks of king mackerel. *Fisheries Research* 57:51-62
- Gagliano M., McCormick M. I. (2004) Feeding history influences otolith shape in tropical fish. *Marine Ecology Progress Series* 278:291-296
- Gobert B. (1990) Production relative des pêcheries côtières en Martinique. *Aquatic Living Resources* 3:181-191
- Gonzales-Salas C., Lenfant P. (2007) Inter-annual variability and intra-annual stability of the otolith shape in European anchovy *Engraulis encrasicolus* (Linnaeus, 1758) in the Bay of Biscay. *Journal of Fish Biology* 70:35-49
- Iwata H., Ukai Y. (2002) SHAPE: A computer program package for quantitative evaluation of biological shapes based on elliptic Fourier descriptors. *The Journal of Heredity* 93:384-385
- Katayama S., Isshiki T. (2007) Variation in otolith macrostructure of Japanese flounder (*Paralichthys olivaceus*): A method to discriminate between wild and released fish. *Journal of Sea Research* 57:180-186
- Kuhl F. P., Giardina C. R. (1982) Elliptic Fourier Features of a Closed Contour. *Computer Graphics and Image Processing* 18:236-258
- L'Abée-Lund J. H. (1988) Otolith shape discriminates between juvenile Atlantic salmon, *Salmo salar* L., and brown trout, *Salmo trutta* L. *Journal of Fish Biology* 33:899-903
- Petursdottir G., Begg G. A., Marteinsdottir G. (2006) Discrimination between Icelandic cod (*Gadus morhua* L.) populations from adjacent spawning areas based on otolith growth and shape. *Fisheries Research* 80:182-189
- Popper A. N., Ramcharitar J., Campana S. E. (2005) Why otoliths? Insights from inner ear physiology and fisheries biology. *Marine and Freshwater Research* 56:497-504
- Pothin K., Gonzalez-Salas C., Chabanet P., Lecomte-Finiger R. (2006) Distinction between *Mulloidichthys flavolineatus* juveniles from Reunion Island and Mauritius Island (south-west Indian Ocean) based on otolith morphometrics. *Journal of Fish Biology* 69:38-53
- Stansky C., Murta A. G., Schlickeisen J., Zimmermann C. (2007) Otolith shape analysis is a tool for stock separation of horse mackerel (*Trachurus trachurus*) in the Northeast Atlantic and Mediterranean. *Fisheries Research*

- Tracey S. R., Lyle J. M., Duhamel G. (2006) Application of elliptical Fourier analysis of otolith form as a tool for stock identification. *Fisheries Research* 77:138-147
- Tuset V. M., Lombarte A., Gonzales B. J., Pertusa J. F., Lorente M. J. (2003) Comparative morphology of the sagittal otolith in *Serranus* spp. *Journal of Fish Biology* 63:1491-1504

## TABLES

Table 1. Otolith shape indices used in this study

Size variables	Shape indices
Length ( $L_0$ )	
Width ( $l_0$ )	Roundness = $4A_0/III_0^2$
Perimeter ( $P_0$ )	Rectangularity = $A_0/(L_0 l_0)$
Area ( $A_0$ )	

Table 2. Shape indices for otolith of *Sparisoma aurofrenatum* at different sites and season. Values are mean $\pm$ SE

	March	October	NTZ Caribbean	FZ Caribbean	NTZ Atlantic	FZ Atlantic
<b>Roundness</b>	0.585 $\pm$ 0.003	0.581 $\pm$ 0.003	0.576 $\pm$ 0.003	0.597 $\pm$ 0.006	0.590 $\pm$ 0.005	<b>0.610<math>\pm</math>0.01</b>
<b>Rectangularity</b>	<b>0.74<math>\pm</math>0.001</b>	<b>0.74<math>\pm</math>0.001</b>	<b>0.71<math>\pm</math>0.001</b>	<b>0.71<math>\pm</math>0.002</b>	<b>0.71<math>\pm</math>0.002</b>	<b>0.71<math>\pm</math>0.004</b>



## FIGURES

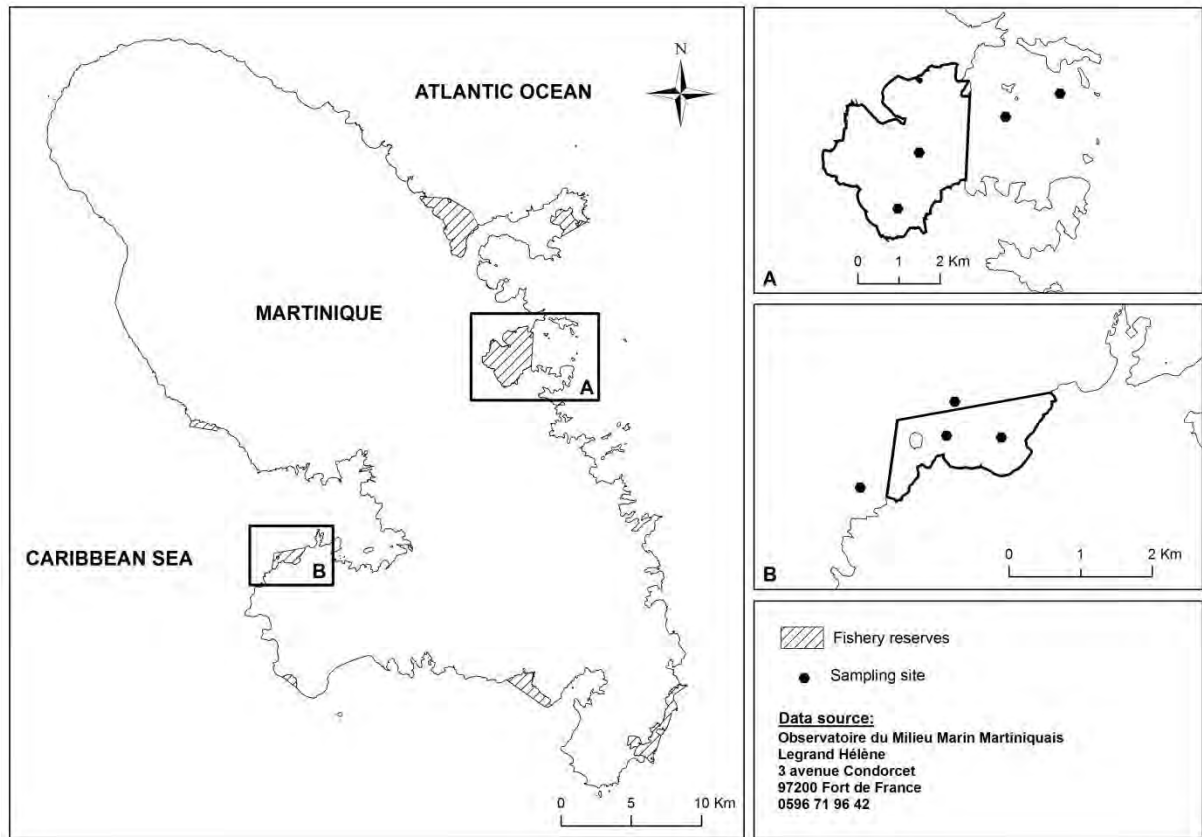


Figure 1. Location of sampling sites: A is Ilet à Ramier and B is Baie du Robert

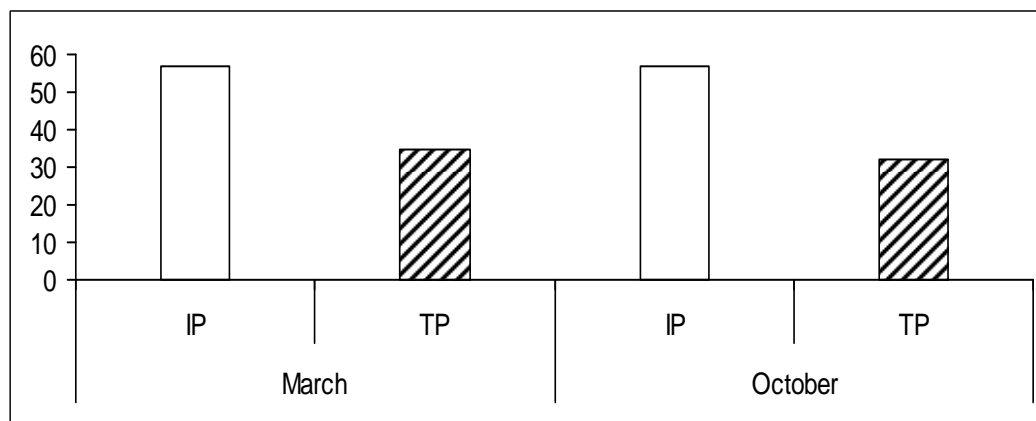


Figure 2. Number of fish of initial phase (IP) and terminal phase (TP) in March and October

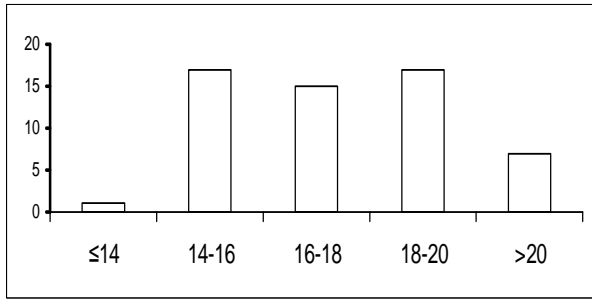


Figure 3. IP length frequency distribution in March

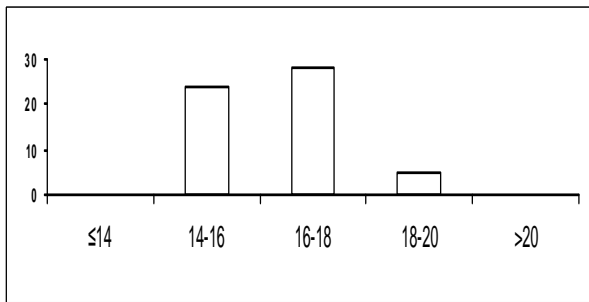


Figure 4. IP length frequency distribution in October

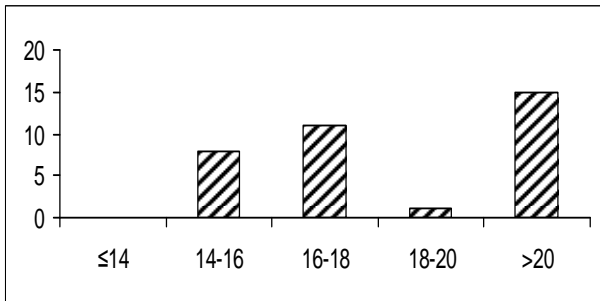


Figure 5. TP length frequency distribution in March

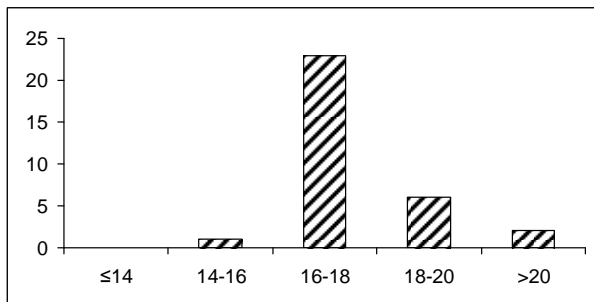


Figure 6. TP length frequency distribution in October

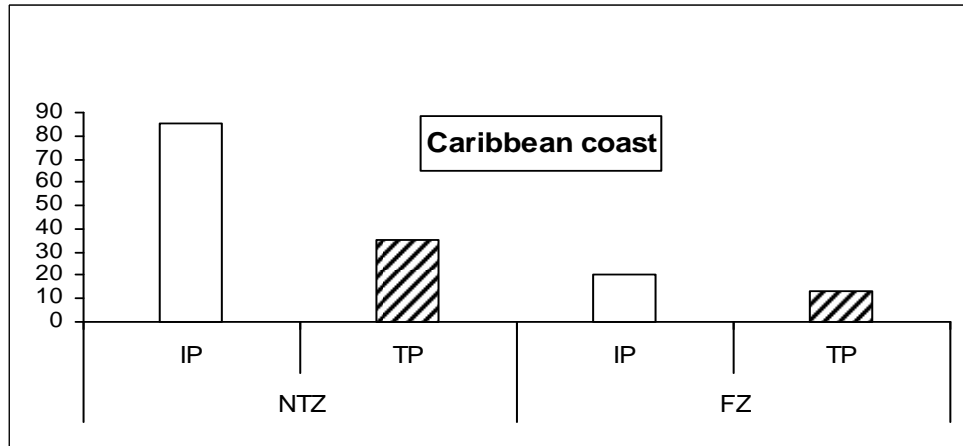


Figure 7. Number of fish of initial phase (IP) and terminal phase (TP) in no-take zone (NTZ) and fishing zone (FZ)

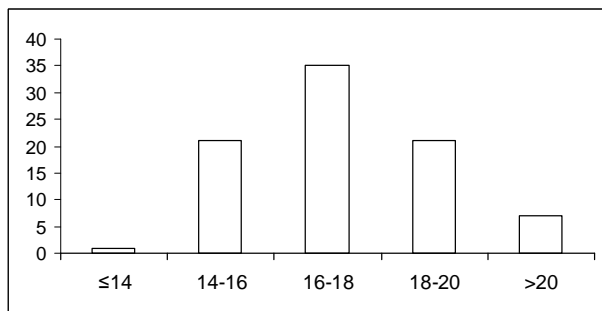


Figure 8. IP length frequency distribution in NTZ of Caribbean coast

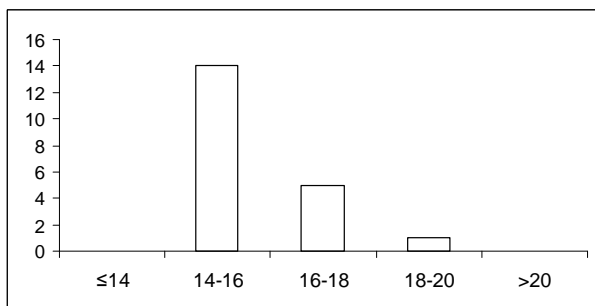


Figure 9. IP length frequency distribution in FZ of Caribbean coast

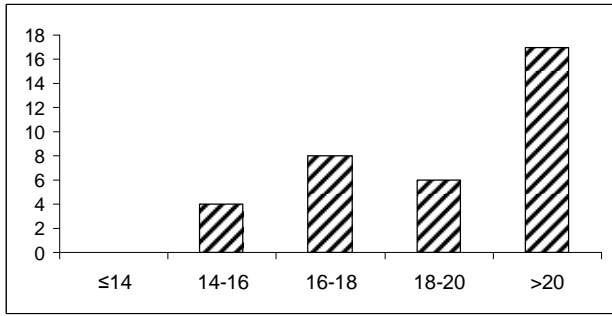


Figure 10. TP length frequency distribution in NTZ of Caribbean coast

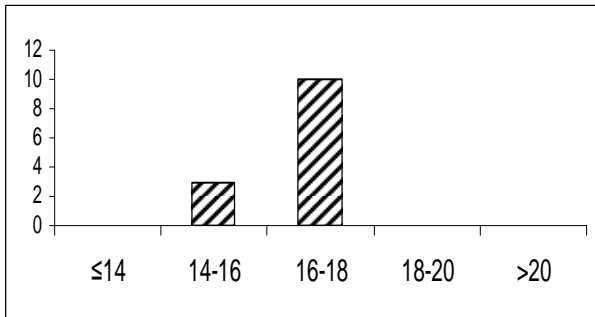


Figure 11. TP length frequency distribution in FZ of Caribbean coast

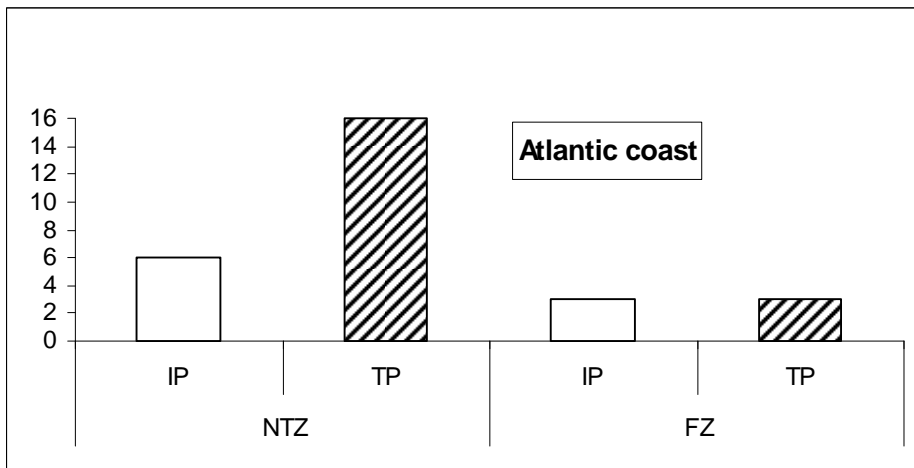


Figure 12. Number of fish of initial phase (IP) and terminal phase (TP) in no-take zone (NTZ) and fishing zone (FZ)

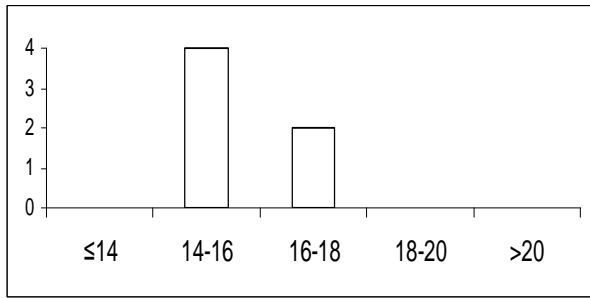


Figure 13. IP length frequency distribution in NTZ of Atlantic coast

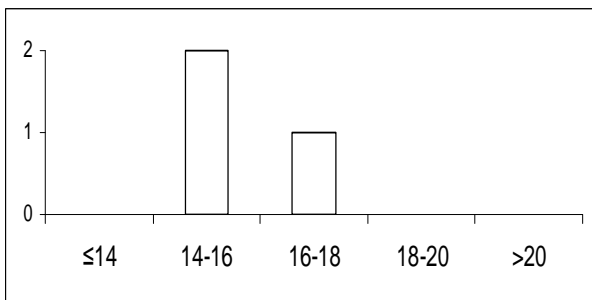


Figure 14. IP length frequency distribution in FZ of Atlantic coast

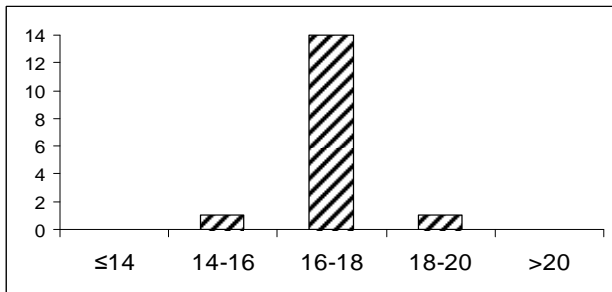


Figure 15. TP length frequency distribution in NTZ of Atlantic coast

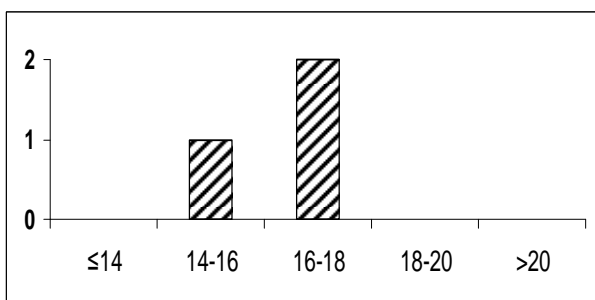


Figure 16. TP length frequency distribution in FZ of Atlantic coast

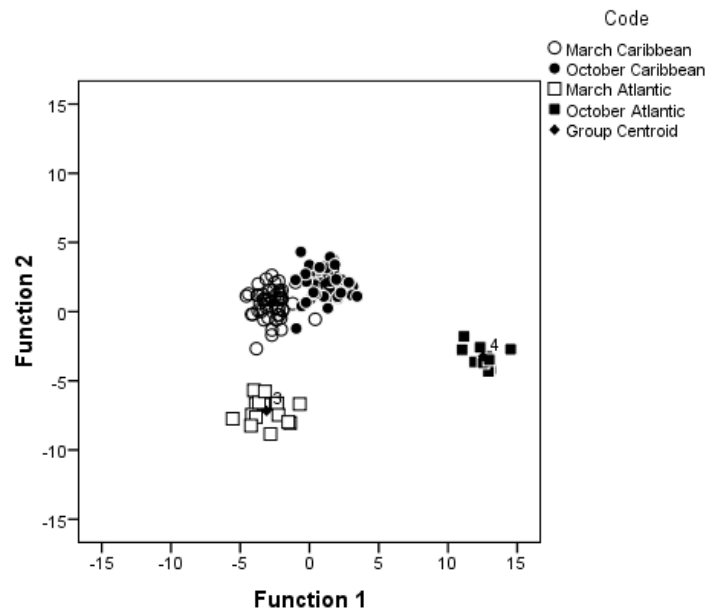


Figure 17. Discrimination between otoliths of *Sparisoma aurofrenatum* from different season and site ( $\lambda < 0.001$ )

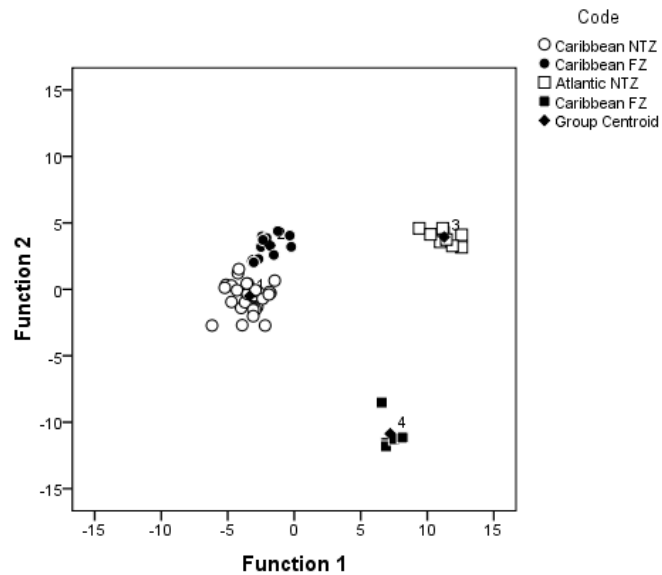


Figure 18. Discrimination between otolith of *Sparisoma aurofrenatum* from protected and unprotected areas of Caribbean and Atlantic sites in March ( $\lambda < 0.001$ )

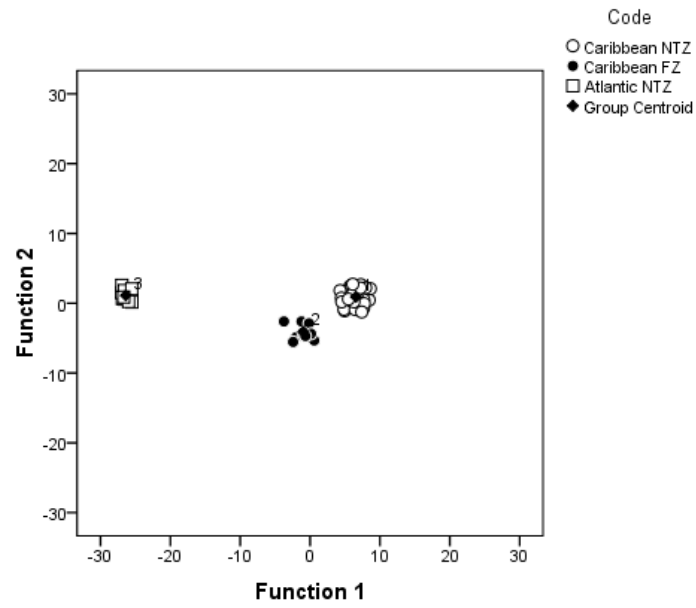


Figure 19. Discrimination between otolith of *Sparisoma aurofrenatum* from protected and unprotected areas of Caribbean and Atlantic sites in October ( $\lambda < 0.001$ )

**CHAPITRE VII**  
**DISCUSSION GENERALE**



## DISCUSSION GENERALE

La plupart des stocks mondiaux sont surexploités et on assiste à un déclin des pêcheries, source de nourriture importante et activité économique principale de millions de personnes (Pauly, 1996; Pauly et al., 2003). Face à l'augmentation croissante de l'effort de pêche et à l'inefficacité des mesures de gestion traditionnelles mises en œuvre seules, les AMP sont de plus en plus considérées comme un outil efficace pour le maintien des stocks et la gestion des pêcheries (Roberts et al., 2001). Actuellement <1% des océans sont protégés alors que les résultats de nombreuses études suggèrent une couverture en zones protégées d'au moins 20% pour vraiment être efficace dans la protection des ressources (Russ et Zeller, 2003). On évolue donc vers un système de « Open access resources » du modèle *Mare Liberum* vers un modèle de *Mare Reservarum* (Russ et Zeller, 2003).

Dans une étude récente, Halpern (2008) fournit une carte de l'impact humain cumulatif montrant un impact très élevé dans une zone de la Caraïbe incluant la Martinique. De nombreuses AMP ont été créées dans cette région (Appeldoorn et Lindeman, 2003; Guarderas et al., 2008) afin de contrer la diminution de l'abondance de nombreuses espèces exploitées (Koslow et al., 1988).

### 1. SYNTHÈSE DES RÉSULTATS

Ce travail a pour but d'évaluer l'impact de la protection sur les communautés de poissons exploitées en vue de fournir des données pour la prise de décisions dans le cadre de la gestion des pêcheries côtières. Il s'agit de la première évaluation des cantonnements de pêche mis en place en Martinique pendant la dernière décennie.

Les analyses des captures obtenues par pêche expérimentales ont montré que les captures totales, les captures spécifiques (Chapitre III) et les tailles moyennes (Chapitre IV) de nombreuses espèces sont supérieures à l'intérieur des deux cantonnements avec toutefois des résultats différents selon les espèces et en fonction du cantonnement considéré.

Les herbivores sont les espèces les plus pêchées quelque soit le niveau de protection et la côte considéré. Ces résultats sont en accord avec les captures par nasses dans l'ensemble des

Antilles (Koslow et al., 1988; Robichaud et al., 2000; Hawkins et al., 2007). Ces espèces répondent fortement à la protection et leurs captures sont en moyenne 6 et 10 fois plus importantes en zone protégée, dans la Baie du Robert et à l'Ilet à Ramier respectivement. Des résultats similaires ont été trouvés dans l'île voisine de Sainte-Lucie (Hawkins et al., 2006), sur la côte orientale africaine (McClanahan et al., 2006a) et au Brésil (Francini-Filho et Moura, 2008aa). Néanmoins, on observe des patterns différents selon les familles. Les captures d'Acanthuridae sont en moyenne 10 et 8 fois supérieures respectivement dans le cantonnement de la Baie du Robert et de l'Ilet à Ramier, mais les différences trouvées ne sont pas significativement dans ce dernier. De plus, les tailles moyennes d'*Acanthurus bahianus* et *Acanthurus chirurgus* sont supérieures dans les deux cantonnements. Roberts (1995) observe également que la taille moyenne d'*A. bahianus* est supérieure dans une réserve marine à Saba alors que Polunin et Roberts (1993) trouvent que les *A. chirurgus* sont petits dans une réserve marine. Les Acanthuridae sont des espèces à faible valeur commerciale alors que leur biomasse représente une importante proportion des captures totales par nasses notamment les juvéniles. Ceci est dû à la hauteur de leur corps engendrant une impossibilité de s'échapper à travers les mailles et les entrées des nasses comme peuvent le faire les juvéniles d'autres espèces (Robichaud et al., 1999). Ainsi 50% des individus d'*A. bahianus* et 95% des individus d'*A. chirurgus* capturés dans la zone exploitée de l'Ilet à Ramier sont immatures (Chapitre IV). Ces résultats montrent que les réserves marines peuvent augmenter le potentiel reproducteur des populations en préservant les individus jusqu'à leur première reproduction (Kaplan, 2009).

Les captures des Scaridae sont en moyenne 5 et 12 fois plus importantes respectivement dans le cantonnement de la baie du Robert et de l'Ilet à Ramier. Néanmoins, les différences entre l'intérieur et l'extérieur des cantonnements ne sont pas significatives la plupart du temps. Par contre, les distributions d'âge et de taille de *Sparisoma aurofrenatum* sont plus largement réparties dans le cantonnement de l'Ilet à Ramier (Chapitre V). L'âge des phases initiales est de 2 à 11 à l'intérieur et de 2 à 7 ans à l'extérieur du cantonnement. Des résultats similaires ont été observés chez la loche saumonée (*Plectropomus leopardus*) et l'empereur à gueule longue (*Lethrinus miniatus*), espèces les plus exploitées par la pêche à la ligne, dans des zones protégées du parc de la Grande Barrière de Corail (Begg et al., 2005b). La taille moyenne des individus de *S. aurofrenatum*, phases initiales et terminales confondues, est supérieure dans le cantonnement, de même que dans une réserve marine de Saba (Roberts, 1995). Dans une précédente étude, la distribution de fréquences de taille de *S. aurofrenatum* capturés par pêches expérimentales à la nasse sur les cotes atlantiques martiniquaises montre

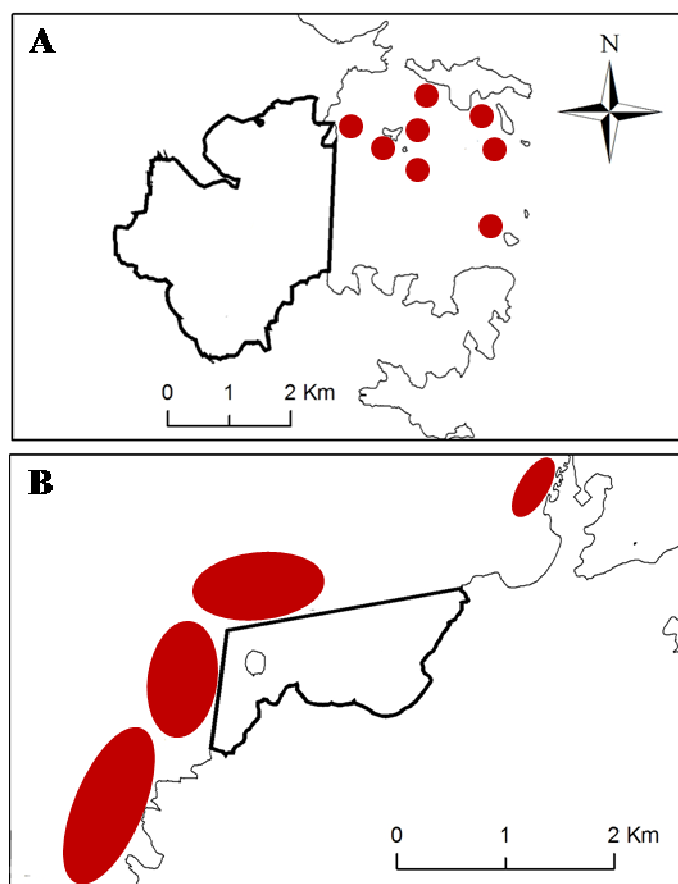
que la plus grande proportion d'individus, soit 20%, avait une taille de 16 cm (Gobert, 1998). En comparaison, lors de ce travail, 90% des individus capturés à l'extérieur du cantonnement ont une taille comprise entre 15 et 18 cm alors que 40% des individus capturés au sein du cantonnement ont une taille comprise entre 18 et 21 cm. Ces résultats suggèrent une augmentation de la taille moyenne des individus de *S. aurofrenatum* depuis la mise en place du cantonnement mais pas dans les zones pêchées. En revanche, il n'y a pas de différence de taille entre l'intérieur et l'extérieur des cantonnements chez *S. viride* et *S. chrysopterum*. Cette dernière ne répond pas à la protection à Sainte-Lucie (Hawkins et Roberts, 2003) alors les individus de *S. viride*, observés à l'intérieur et à l'extérieur d'une réserve marine au Belize, ont en moyenne une taille supérieure dans la zone protégée (Polunin et Roberts, 1993).

L'effet de la protection sur les espèces carnivores ne semble pas marqué. Même si la capturabilité décroît avec la taille des poissons, Gobert (1994) rapporte lors d'enquêtes auprès des pêcheurs, de fortes prises de Serranidae et de Lutjanidae de grande taille 30 à 40 ans en arrière donc bien avant la mise en place des cantonnements. Les individus de *Cephalopholis fulva* sont en moyenne plus grands dans le cantonnement de l'Ilet à Ramier mais, on n'observe pas de différence de taille entre cantonnements et zones pêchées chez *Haemulon flavolineatum*, *Ocyurus chrysurus* et *Lutjanus synagris*. Pourtant, les biomasses de Lutjanidae, d'Haemulidae et de Serranidae sont supérieures dans la réserve marine de Saba (Polunin et Roberts, 1993), les biomasses et densités des Serranidae et des Lutjanidae ont augmenté dans cinq réserves de Nouvelle-Calédonie mais pas les tailles moyennes (Wantiez et al., 1997) ; et les biomasses de *Lutjanus fulviflamma* sont 6 à 7 fois supérieures et sa taille plus grande de 37% dans le parc marin de l'île de Mafia en Tanzanie (Kamukuru et al., 2004). Plusieurs hypothèses sont avancées pour expliquer nos résultats. Premièrement, il a été suggéré que les réserves offrent une meilleure protection aux espèces sédentaires (Botsford et al., 2003). Or nos résultats suggèrent que les espèces mobiles réagissent aussi à la protection. De plus, des études précédentes ont montré que les espèces récifales même mobiles présentent une forte fidélité à leurs sites (Chapman et Kramer, 1999, 2000) et que les déplacements de plus de 250 m au-delà des limites d'une zone protégée représentent moins de 1% des déplacements totaux observés (Zeller et al., 2003). Deuxièmement, les bénéfices de la protection pour les espèces surexploitées à croissance lente et longue durée de vie passeraient par des processus écologiques longs (McClanahan et Graham, 2005). Par exemple, les effets de la protection sur les populations de *Balistapus undulatus* sur les côtes orientales africaines ont été ressentis après plus de 10 ans (McClanahan, 2000). Or, ce travail est réalisé moins de 10 ans après la création des cantonnements avec un niveau d'exploitation des ressources très élevé.

Troisièmement, les faibles taux de captures des espèces carnivores et piscivores induisent un manque de puissance dans les analyses statistiques. Ces deux dernières hypothèses semblent les plus plausibles pour expliquer nos résultats.

Néanmoins, la taille maximale et la taille moyenne des espèces sont toujours plus grandes dans les cantonnements, même quand la différence n'est pas significative, sauf pour *S. chrysopteron* à l'Ilet à Ramier. Ce résultat rejoint celui du Chapitre III montrant que les captures des poissons de grande taille sont en général supérieures dans les cantonnements, ce qui indique un plus grand potentiel reproducteur dans les zones protégées (Birkeland et Dayton, 2005; Evans et al., 2008; Kaplan, 2009).

Les cantonnements étudiés dans ce travail n'ont pas la même performance. En effet le cantonnement de la Baie du Robert semble fournir une meilleure protection que celui de l'Ilet à Ramier où les différences observées dans les captures ne sont pas significatives la plupart du temps. Plusieurs facteurs sont à prendre en compte. Le cantonnement de l'Ilet à Ramier s'étend sur 184 h. Pourtant, de nombreuses aires marines protégées ayant une taille plus petite ont montré de fortes réponses des espèces à la protection comme par exemple les réserves marines de Apo (22,5 ha) et Sumilon (37,5 ha) aux Philippines, la réserve marine de la Barbade (66 ha), la zone protégée de Carry-le-Rouet (85 ha) sur les côtes méditerranéennes françaises, ou encore la zone protégée de Nabq en Égypte (120 ha). Le pattern de distribution et d'intensité de l'effort de pêche diffère entre les deux zones. En général, l'effort de pêche diminue avec la distance depuis les limites des réserves marines (McClanahan et Kaunda - Arara, 1996; Kaunda - Arara et Rose, 2004; Stelzenmüller et al., 2008). Dans le cas présent, on observe une concentration importante de nasses le long des limites du cantonnement de l'Ilet à Ramier mais cet effort de pêche ne diminue pas avec la distance et est même supérieur sur certaines zones de pêche (obs. pers.). Dans la Baie du Robert, l'effort de pêche est nul le long de la limite du cantonnement, à cause de la nature vaseuse des fonds non propice à la pause de nasses ou de filets de fond, sauf au niveau du récif de l'ilet Petite Martinique (limite nord) ; l'effort de pêche se concentre autour des ilets bordés de récifs et d'herbiers (obs. pers.) (Fig. 13). Au final, l'effort de pêche, ramené à la surface de la zone exploitée, est beaucoup plus important à l'Ilet à Ramier que dans la Baie du Robert. Nos observations concordent avec celles de Gobert et Stanisière (1997) sur la répartition spatiale de l'effort de pêche aux nasses montrant que l'effort relatif corrigé est de  $3,42 \times 10^3$  nasses.km<sup>2</sup> dans le secteur de la Baie de Fort-de-France et de  $1,91 \times 10^3$  nasses.km<sup>2</sup> dans le secteur Sud-Atlantique (intérieur du récif).



**Figure 13.** Répartition de l'effort de pêche dans les zones exploitées voisines des cantonnements de la Baie du Robert (A) et de l'Ilet à Ramier (B).

Un autre facteur relativement délicat à quantifier est le braconnage. En effet, de nombreuses nasses ont été observées au sein de l'Ilet à Ramier tout au long de notre échantillonnage. Cette pratique semble être permanente tout au long de l'année selon les dires de certains pêcheurs et pourrait compromettre l'efficacité du cantonnement de l'Ilet à Ramier. Dans le cantonnement de la Baie du Robert, la situation est différente car nous n'avons observé aucune nasse au sein du cantonnement, ce qui nous a été confirmé par plusieurs pêcheurs. Par contre, nous avons pu observer à plusieurs reprises des braconniers pêchant des langoustes, abondantes dans cette zone, en apnée en partant à pied du bord. D'autre part, le cantonnement de l'Ilet à Ramier a été ré-ouvert à la pêche durant 7 mois en 2007. N'ayant pas été prévenus, nous n'avons pu adapter notre protocole d'échantillonnage afin d'évaluer l'impact de cette réouverture et nos résultats ne nous permettent pas de tirer des conclusions sur les effets sur les peuplements de poissons du cantonnement. De précédentes études ont analysé l'impact de la réouverture de zones protégées à la pêche. En Nouvelle-Calédonie, la réserve du récif d'Abore a été ré-

ouverte pendant 2 ans induisant une diminution de la densité des macrocarnivores, des piscivores et des herbivores (Ferraris et al., 2005). La réouverture pendant 18 mois de la réserve de Sumilon aux Philippines a entraîné une diminution des prédateurs de grande taille (Alcala et Russ, 1990; Russ et Alcala, 1998). Malgré une durée de réouverture plus courte et l'impossibilité de conclure sur l'impact avec nos résultats, la réouverture périodique de petites zones protégées pourrait compromettre l'efficacité de la mise en protection et donc affecter la gestion et le maintien de pêcheries (McClanahan et al., 2006b). De plus, le braconnage a augmenté suite à cette réouverture, certains pêcheurs ayant continué à pêcher dans le cantonnement après la fermeture (obs. pers.).

Un résultat inattendu concerne l'évolution temporelle des captures à l'intérieur et à l'extérieur des cantonnements après le passage du cyclone Dean qui a violemment frappé les côtes martiniquaises, particulièrement atlantiques, en août 2007. Dans la Baie du Robert, les captures de la plupart des espèces ont diminué. Cette diminution n'est pas significative dans le cantonnement mais s'avère dramatique dans les zones exploitées adjacentes. Nous l'attribuons au passage du cyclone car cette diminution change de la variabilité temporelle observée en général dans la structure des communautés de poissons (Galzin, 1987; Louis et al., 1995). L'impact immédiat des cyclones sur l'ichtyofaune se traduit par des changements de comportement, de distribution et d'abondance des espèces. Une augmentation des espèces mobiles de grande taille, une diminution de la densité d'herbivores, une perte du comportement de territorialité et une inversion des comportements nocturnes et diurnes chez certaines espèces ont été observées (Woodley et al., 1981; Kaufman, 1983; Fitzsimons et Nishimoto, 1995; Cheal et al., 2002). D'un côté, certains de ces changements sont susceptibles d'augmenter la capturabilité des poissons sur une courte durée. D'un autre côté, les biomasses étant déjà inférieures dans les zones exploitées, les captures donc sont susceptibles de diminuer. Nos résultats suggèrent que le cyclone exacerbe les effets de la pêche et inversement, et que les peuplements de poissons dans le cantonnement sont restés plus stables. Ces effets immédiats sont accompagnés d'effets indirects via la dégradation et la perte d'habitats côtiers incluant les herbiers (Duarte, 2002), les mangroves (Alongi, 2002) et les récifs coralliens (Hughes et al., 2003; Gardner et al., 2005) essentiels à l'installation et à la survie de nombreuses espèces exploitées (Dorenbosch et al., 2007; Grober-Dunsmore et al., 2007; Munday et al., 2008). Certains auteurs suggèrent que les AMP mitigent l'impact des catastrophes naturelles (Gardner et al., 2003; Game et al., 2008; Graham et al., 2008) dont le

nombre, la durée et l'intensité sont en augmentation depuis les 35 dernières années (Webster et al., 2005).

## **2. CONCLUSIONS ET PERSPECTIVES**

Ce travail constitue l'étude de référence sur l'impact de deux cantonnements de pêche et les résultats obtenus permettent de jeter les premières pierres pour l'élaboration et la planification d'un programme de suivi du réseau de cantonnements de pêche de la Martinique. La plupart des études sur les effets des AMP utilisent un nombre limité de paramètres, le plus souvent les abondances, la taille moyenne ou les CPUE. Dans le cadre de ce travail, différents paramètres biologiques ont été utilisés permettant une approche holistique afin de maximiser les chances de détecter des signaux (Begg et Waldman, 1999) et de rentabiliser les prélèvements notamment en zones protégées.

L'absence de point zéro ne nous permet pas de conclure que les pêcheries avoisinantes ont bénéficié de la mise en place de la protection. Néanmoins, l'échantillonnage mis en place sur des habitats similaires avec des répliquas spatiaux et temporels nous a permis de séparer l'effet protection de la variabilité naturelle spatiale et temporelle des peuplements de poissons.

D'un point de vue méthodologique, l'originalité de ce travail est l'utilisation de l'outil otolithe pour l'évaluation de l'impact de la protection, notamment l'analyse de forme. Selon Campana (2005), parmi toutes les publications récentes sur l'otolithe 23% concernent l'âge et la croissance et 4% seulement l'analyse de la forme. De même, lors du 3<sup>e</sup> Symposium sur l'Otolithe en Australie en 2004, 80% des présentations portaient sur l'âge et la croissance (Begg et al., 2005a). Très peu d'études analysent la croissance en zones protégées et aucune n'a utilisé l'analyse de forme afin de distinguer les individus de zones exploitées et protégées. Nous avons rencontré des difficultés pour obtenir suffisamment d'otolithes selon la localité, le niveau d'exploitation et la saison en raison des captures faibles à moyennes des espèces les plus intéressantes d'un point de vue de la valeur commerciale. Il serait intéressant d'analyser la forme en appliquant la technique de géomorphométrie afin de visualiser et de quantifier les différences de forme (Ponton, 2006), et de déterminer si les différences entre zones protégées et non protégées affectent toujours le même endroit sur le contour de l'otolithe. L'analyse de forme devrait être réalisée pour chaque classe d'âge, selon le sexe et devrait être

complétée par la condition évaluée par les indices morphométriques, physiologiques, biochimiques, gonado-somatiques et hépato-somatiques.

Ce travail sera à mettre en parallèle avec les travaux d'autres doctorants : J. Garcia étudie les déplacements des espèces exploitées entre zones protégées et non protégées (parmi lesquels les cantonnements de la Baie du Robert et de l'Ilet à Ramier) par marquage externe et tracking acoustique, H. Legrand achève la cartographie des biocénoses marines côtières de la Martinique et Y. Rousseau étudie la relation entre la qualité de l'habitat et les peuplements de poissons.

Il est important de poursuivre l'évaluation de l'impact de la mise en place de tous les cantonnements car un manque de suivi, d'objectifs clairs et d'implication de la communauté de pêcheurs diminueront l'efficacité des zones protégées (Hillborn et al., 2004; Lundquist et Granek, 2005). Ainsi, il serait indispensable de cartographier (dynamique dans le temps) l'effort de pêche et les captures ainsi que de répertorier les types d'engins utilisés dans les zones exploitées adjacentes aux cantonnements. Au vue des résultats, il semblerait impératif de passer à une taille minimale légale de maille de 38 mm, que certains pêcheurs utilisent déjà, et d'observer comment évoluent les captures. Comme nous l'avons déjà souligné, la dimension humaine joue un rôle important dans le succès des AMP, il serait donc intéressant d'étudier la perception de ces zones protégées par la communauté de pêcheurs et de regarder comment cette perception évolue dans le temps en fonction de l'apport de résultats scientifiques sur l'impact de la protection.



# **BIBLIOGRAPHIE**

- Abesamis R.A., Alcala A.C. and Russ G.R. (2006) How much does the fishery at Apo Island benefit from spillover of adult fish from the adjacent marine reserve? *Fish Bull* **104**:360-375
- Ainsworth C.H., Varkey D.A. and Pitcher T.J. (2008) Ecosystems simulations supporting ecosystem-based fisheries management in the Coral Triangle, Indonesia. *Ecol Model* **214**:361-374
- Alcala A.C. and Russ G.R. (1990) A direct test of the effects of protective management on abundance and yield of tropical marine resources. *Journal du Conseil international pour l'Exploration de la Mer* **47**:40-47
- Allison G.W., Gaines S.D., Lubchenco J. and Possingham H.P. (2003) Ensuring persistence of marine reserves: catastrophes require adopting an insurance factor. *Ecol Appl* **13**:S8-S24
- Allison G.W., Lubchenco J. and Carr M.H. (1998) Marine reserves are necessary but not sufficient for marine conservation. *Ecol Appl* **8**:S79-S92
- Alongi D.M. (2002) Present state and future of the world's mangrove forests. *Biol Conserv* **29**:331-349
- Amilhat E. (1999) Estimation de la durée de vie larvaire et caractérisation de la croissance des Scaridae et Acanthuridae de Discovery Bay, Jamaïque. *Diplôme d'Etudes Supérieures de Sciences Université Pierre et Marie Curie (Paris VI)*:82p
- Appeldoorn R.S. and Lindeman K.C. (2003) A Caribbean-wide survey of marine reserves: spatial coverage and attributes of effectiveness. *Gulf Caribb Res* **14**:139-154
- Ashworth J.S. and Ormond R.F.G. (2005) Effects of fishing pressure and trophic group on abundance and spillover across boundaries of a no-take zone. *Biol Conserv* **121**:333-344
- Barrett N.S., Edgar G.J., Buxton C.D. and Haddon M. (2007) Changes in fish assemblages following 10 years of protection in Tasmanian marine protected areas. *J Exp Mar Biol Ecol* **345**:141-157
- Begg G.A., Campana S.E., Fowler A.J. and Suthers I.M. (2005a) Otolith research and application: current directions in innovation and implementation. *Mar Freshw Res* **56**:477-483
- Begg G.A., Mapstone B.D., Williams A.J., Adams S., Davies C.R. and Lou D.C. (2005b) Multivariate life-history indices of exploited coral reef fish populations used to measure the performance of no-take zones in a marine protected area. *Can J Fish Aquat Sci* **62**:679-692

- Begg G.A. and Waldman J.R. (1999) A holistic approach to fish stock identification. *Fish Res* **43**:35-44
- Bellwood D.R., Hughes T.P., Folke C. and Nyström M. (2004) Confronting the coral reef crisis. *Nature* **429**:827-833
- Bianchi G., Gislason H., Graham K., Hill L., Jin X., Koranteng K., Manickchand-Heileman S.C., Paya I., Sainsbury K., Sanchez F. and Zwanenburg K. (2000) Impact of fishing on size composition and diversity of demersal fish communities. *ICES J Mar Sci* **57**:558-571
- Birkeland C. and Dayton P.K. (2005) The importance in fishery management of leaving the big ones. *Trends Ecol Evol* **20**:356-358
- Bohnsack J.A. (1998) Application of marine reserves to reef fisheries management. *Aust J Ecol* **23**:298-304
- Botsford L.W., Micheli F. and Hastings A. (2003) Principles for design of marine reserves. *Ecol Appl* **13**:S25-S31
- Bruggemann J.H., Begeman J., Bosma E.M., Verburg P. and Breeman A.M. (1994a) Foraging by the stoplight parrotfish *Sparisoma viride*. II. Intake and assimilation of food, protein and energy. *Mar Ecol Prog Ser* **106**:57-71
- Bruggemann J.H., Kuyper M.W. and Breeman A.M. (1994b) Comparative analysis of foraging and habitat use by the sympatric Caribbean parrotfish *Scarus vetula* and *Sparisoma viride* (Scaridae). *Mar Ecol Prog Ser* **112**:51-66
- Bruggemann J.H., van Oppen M.J.H. and Breeman A.M. (1994c) Foraging by the stoplight parrotfish *Sparisoma viride*. I. Food selection in different, socially determined habitats. *Mar Ecol Prog Ser* **106**:41-55
- Burke N., Brophy D. and King P.A. (2008) Shape analysis of otolith annuli in Atlantic herring (*Clupea harengus*); a new method for tracking fish populations. *Fish Res* **91**:133-143
- Campana S.E. (1999) Chemistry and composition of fish otoliths: pathways, mechanisms and applications. *Mar Ecol Prog Ser* **188**:263-297
- Campana S.E. (2005) Otolith science entering the 21st century. *Mar Freshw Res* **56**:485-495
- Campana S.E. and Casselman J.M. (1993) Stock discrimination using otolith shape analysis. *Can J Fish Aquat Sci* **50**:1062-1083
- Campana S.E. and Neilson J.D. (1985) Microstructure of fish otoliths. *Can J Fish Aquat Sci* **42**:1014-1032

- Carr M.H., Neigel J.E., Estes J.A., Andelman S., Warner R.R. and Largier J. (2003) Comparing marine and terrestrial ecosystems: implications for design of coastal marine reserves. *Ecol Appl* **13**:S90-S107
- Chape S., Harrison J., Spalding M. and Lysenko I. (2005) Measuring the extent and effectiveness of protected areas as an indicator for meeting global biodiversity targets. *Philos Trans R Soc Lond B Biol Sci* **360**:443-455
- Chapman M.R. and Kramer D.L. (1999) Gradients in coral reef fish density and size across the Barbados marine reserve boundary: effects of reserve protection and habitat characteristics. *Mar Ecol Prog Ser* **181**:81-96
- Chapman M.R. and Kramer D.L. (2000) Movements of fishes within and among fringing coral reefs in Barbados. *Environ Biol Fishes* **57**:11-24
- Cheal A.J., Coleman F.C., Delean S., Miller I., Osborne K. and Sweatman H. (2002) Response of coral and fish assemblages to a severe but short-lived tropical cyclone on the Great Barrier Reef, Australia. *Coral Reefs* **21**:131-142
- Chiappone M., Sluka R. and Sealey K.S. (2000) Groupers (Pisces: Serranidae) in fished and protected areas of the Florida Keys, Bahamas and northern Caribbean. *Mar Ecol Prog Ser* **198**:261-272
- Choat J.H., Axe L.M. and Lou D.C. (1996) Growth and longevity in fishes of the family Scaridae. *Mar Ecol Prog Ser* **145**:33-41
- Choat J.H., Robertson D.R., Ackerman J.L. and Posada J.M. (2003) An age-based demographic analysis of the Caribbean stoplight parrotfish *Sparisoma viride*. *Mar Ecol Prog Ser* **246**:265-277
- Claudet J. (2006) Aires Marines Protégées et Récifs Artificiels: méthodes d'évaluation, protocoles expérimentaux et indicateurs. *Thèse de l'Université de Perpignan et de l'Ecole Pratique des Hautes Etudes*:Perpignan, 254 pp
- Claudet J., Osenberg C.W., Benedetti-Cecchi L., Domenici P., Garcia-Charton J.A., Perez-Rufaza A., Badalamenti F., Bayle-Sempere J., Brito A., Bulleri F., Culioli J.-M., Dimech M., Falcon J.M., Guala I., Milazzo M., Sanchez-Meca J., Somerfield P.J., Stobart B., Vandeperre F., Valle C. and Planes S. (2008) Marine reserves: size and age do matter. *Ecol Lett* **11**:481-489
- Claudet J., Pelletier D., Jouvenel J.-Y., Bachet F. and Galzin R. (2006) Assessing the effects of Marine Protected Area (MPA) on a reef fish assemblage in a northwestern Mediterranean Marine Reserve: Identifying community based indicators. *Biol Conserv* **130**:349-369

- Côté I.M., Mosqueira I. and Reynolds J.D. (2001) Effects of marine reserve characteristics on the protection of fish populations: a meta analysis. *J Fish Biol* **59**:178-189
- Crampton J.S. (1995) Elliptic Fourier shape analysis of fossil bivalves: some practical considerations. *Lethaia* **28**:179-186
- Dazell P. (1998) The role of archaeological and cultural-historical records in long-range coastal fisheries resources management strategies and policies in the Pacific Islands. *Ocean Coast Manag* **40**:237-252
- De' ath G. (2002) Multivariate regression trees: a new technique for modelling species-environment relationships. *Ecology* **83**:1105-1117
- DeMartini E.E., Friedlander A.M., Sandin S.A. and Sala E. (2008) Differences in fish-assemblage structure between fished and unfished atolls in the northern Line Islands, central Pacific. *Mar Ecol Prog Ser* **365**:199-215
- Denny C.M. and Babcock R.C. (2004) Do partial marine reserves protect reef fish assemblages? *Biol Conserv* **116**:119-129
- Denny C.M., Willis T.J. and Babcock R.C. (2004) Rapid recolonisation of snapper *Pagrus auratus*: Sparidae within an offshore island marine reserve after implementation of no-take status. *Mar Ecol Prog Ser* **272**:183-190
- DeVries D.A., Grimes C.B. and Prager M.H. (2002) Using otolith shape analysis to distinguish eastern Gulf of Mexico and Atlantic Ocean stocks of king mackerel. *Fish Res* **57**:51-62
- Dorenbosch M., Verberk W.C.E.P., Nagelkerken I. and van der Velde G. (2007) Influence of habitat configuration on connectivity between fish assemblages of Caribbean seagrass beds, mangroves and coral reefs. *Mar Ecol Prog Ser* **334**:103-116
- Duarte C.M. (2002) The future of seagrass meadows. *Environ Conserv* **29**:192-206
- Dufrêne M. and Legendre P. (1997) Species assemblages and indicators species: the need for a flexible asymmetrical approach. *Ecol Monogr* **67**:345-366
- Dulvy N.K., Freckelton R.P. and Polunin V.C. (2004a) Coral reef cascades and the indirect effects of predator removal by exploitation. *Ecol Lett* **7**:410-416
- Dulvy N.K., Polunin N.V.C., Mill A.C. and Graham N.A.J. (2004b) Size structural change in lightly exploited coral reef fish communities: evidence for weak indirect effects. *Can J Fish Aquat Sci* **61**:466-475
- Evans R.D., Russ G.R. and Kritzer J.P. (2008) Batch fecundity of *Lutjanus carponotatus* (Lutjanidae) and implications of no-take marine reserves. *Coral Reefs* **27**:179-189

- Ferraris J., Pelletier D., Kulbicki M. and Chauvet C. (2005) Assessing the impact of removing reserve status on the Abore Reef fish assemblage in New Caledonia. *Mar Ecol Prog Ser* **292**:271-286
- Fitzsimons J.M. and Nishimoto R.T. (1995) Use of fish behavior in assessing the effects of Hurricane Iniki on the Hawaiian island of Kaua'i. *Environ Biol Fishes* **45**:39-50
- Floeter S.R., Halpern B.J. and Ferreira C.E.L. (2006) Effects of fishing and protection on Brazilian reef fishes. *Biol Conserv* **128**:391-402
- Forcada A., Bayle-Sempere J.T., Valle C. and Sanchez-Jerez P. (2008) Habitat continuity effects on gradients of fish biomass across marine protected area boundaries. *Mar Environ Res* **66**:536-547
- Forcada A., Valle C., Bonhomme P., Criquet G., Cadiou G., Lenfant P. and Sanchez-Lizaso J.-L. (2009) Effects of habitat on spillover from marine protected areas to artisanal fisheries. *Mar Ecol Prog Ser* **379**:197-211
- Francini-Filho R.B. and Moura R.L. (2008a) Dynamics of fish assemblages on coral reefs subjected to different management regimes in the Abrolhos Bank, eastern Brazil. *Aquatic Conservation: Marine and Freshwater Ecosystems* **18**:1166-1179
- Francini-Filho R.B. and Moura R.L. (2008b) Evidence for spillover of reef fishes from a no-take marine reserve: An evaluation using the before-after control-impact (BACI) approach. *Fisheries Research* **93**:346-356
- Fraschetti S., Terlizzi A., Micheli F., Benedetti-Cecchi L. and Boero F. (2002) Marine protected areas in the Mediterranean Sea: objectives, effectiveness and monitoring. *Mar Ecol* **23**:190-200
- Friedland K.D. and Reddin D.G. (1994) Use of otolith morphology in stock discriminations of atlantic salmon (*Salmo salar*). *Can J Fish Aquat Sci* **51**:91-98
- Friedlander A.M., Brown E.K. and Monaco M.E. (2007) Coupling ecology and GIS to evaluate efficacy of marine protected areas in Hawaii. *Ecol Appl* **17**:715-730
- Friedlander A.M. and DeMartini E.E. (2002) Contrasts in density, size and biomass of reef fishes between the northwestern and the main Hawaiian islands: the effects of fishing down apex predators. *Mar Ecol Prog Ser* **203**:253-264
- Gagliano M. and McCormick M.I. (2004) Feeding history influences otolith shape in tropical fish. *Mar Ecol Prog Ser* **278**:291-296
- Galzin R. (1987) Structure of fish communities of French Polynesian coral reef. II. Temporal scales. *Mar Ecol Prog Ser* **41**:137-145

- Game E.T., McDonald-Madden E., Puotinen M.L. and Possingham H.P. (2008) Should we protect the strong or the weak? Risk, resilience, and selection of marine protected areas. *Conserv Biol* **22**:1619-1629
- García-Charton J.A. and Pérez-Rufaza A. (1999) Ecological heterogeneity and evaluation of effects of marine reserves. *Fish Res* **42**:1-20
- García-Charton J.A., Pérez-Rufaza A., Sánchez-Jerez P., Bayle-Sempere J., Reñones O. and Moreno D. (2004) Multi-scale spatial heterogeneity, habitat structure, and effect of marine reserves on Western Mediterranean rocky reef fish assemblages. *Mar Biol* **144**:161-182
- Gardner T.A., Côté I.M., Gill J.A., Grant A. and Watkinson A.R. (2005) Hurricanes and Caribbean reefs: impact, recovery patterns, and role in long-term decline. *Ecology* **86**:174-184
- Gardner Y.A., Côté I.M., Gill J.A., Grant A. and Watkinson A.R. (2003) Long-term region-wide declines in Caribbean corals. *Science* **301**:958-960
- Garrison V.H., Rogers C.S., Beets J.P. and Friedlander A.M. (2004) The habitats exploited and the species trapped in a Caribbean island trap fishery. *Environ Biol Fishes* **71**:247-260
- Gerber L.R., Kaveiva P.M. and Bascompte J. (2002) The influence of life history attributes and fishing pressure on the efficacy of marine reserves. *Biol Conserv* **106**:11-18
- Giardina C.R. and Kuhl F.P. (1997) Accuracy of curve approximation by harmonically related vectors with elliptical loci. *Comput Graph Image Process* **6**:277-285
- Gislason H. and Rice J. (1998) Modelling the response of size and diversity spectra of fish assemblages to changes in exploitation. *ICES J Mar Sci* **55**:362-370
- Glasby T.M. (1997) Analyzing data from post-impact studies using asymmetrical analyses of variance: A case study of epibiota on marinas. *Aust J Ecol* **22**:448-459
- Gobert B. (2000) Comparative assessment of multispecies reef fish resources in the Lesser Antilles. *Fish Res* **44**:247-260
- Gobert B. (1998) Density - dependent size selectivity in Antillean fish traps. *Fish Res* **38**:159-167
- Gobert B. (1992) Impact of the use of trammelnets on a tropical reef resource. *Fish Res* **13**:353-367
- Gobert B. (1990) Production relative des pêcheries côtières en Martinique. *Aquat Living Resour* **3**:181-191

- Gobert B. (1994) Size structure of demersal catches in a multispecies multigear tropical fishery. *Fish Res* **19**:87-104
- Gobert B. and Stanisière J.-Y. (1997) Répartition spatiale de l'effort de pêche aux nasses en Martinique (Antilles). *Aquat Living Resour* **10**:93-100
- Goñi R., Adlerstein S., Alavarez-Berastegui D., Forcada A., Renones O., Criquet G., Polti S., Cadiou G., Valle C., Lenfant P., Bonhomme P., Perez-Rufaza A., Sanchez-Lizaso J.-L., Garcia-Charton J.A., Bernard G., Stelzenmüller V. and Planes S. (2008) Evidence of spillover from six Western Mediterranean marine protected areas measured from artisanal fisheries. *Mar Ecol Prog Ser* **366**:159-174
- Gonzales-Salas C. and Lenfant P. (2007) Inter-annual variability and intra-annual stability of the otolith shape in European anchovy *Engraulis encrasicolus* (L.) in the Bay of Biscay. *J Fish Biol* **70**:35-49
- Graham N.A.J., Dulvy N.K., Jennings S. and Polunin N.V.C. (2005) Size-spectra as indicators of the effects of fishing on coral reef fish assemblages. *Coral Reefs* **24**:118-124
- Graham N.A.J., Evans R.D. and Russ G.R. (2003) The effects of marine reserve protection on the trophic relationships of reef fishes on the Great Barrier Reef. *Environ Conserv* **30**:200-208
- Graham N.A.J., McClanahan T.R., MacNeil M.A., Wilson S.K., Polunin N.V.C., Jennings S., Chabanet P., Clarke S., Spalding M.D., Letourneur Y., Bigot L., Galzin R., Öhman M.C., Garpe K.C., Edwards A.J. and Sheppard C.R.C. (2008) Climate warming, marine protected areas and the ocean-scale integrity of coral reef ecosystems. *PLoS One* **3**:e3039. doi:3010.1371/journal.pone.0003039
- Grober-Dunsmore R., Frazer T.K., Lindberg W.J. and Beets J.P. (2007) Reef fish and habitat relationships in a Caribbean seascape: the importance of reef context. *Coral Reefs* **26**:201-216
- Guarderas A.P., Hacker S.D. and Lubchenco J. (2008) Current status of marine protected areas in Latin America and the Caribbean. *Conserv Biol* **22**:1630-1640
- Guillou A. and Lagin A. (1997) Engins et techniques de pêche de la Martinique. *Rapport interne IFREMER RI-DRV/RH/RST/97-10*:218p
- Halpern B.J. (2003) The impact of marine reserves: Do reserves work and does reserve size matter? *Ecol Appl* **13**:117-137
- Halpern B.J., Walbridge S., Selkoe K.A., Kappel C.V., Micheli F., D'Agrosa C., Bruno J.F., Casey K.S., Ebert C., Fox H.E., Fujita R., Heinemann D., Lenihan H.S., Madin



- E.M.P., Perry M.T., Selig E.R., Spalding M., Steneck R.S. and Watson R. (2008) A global map of human impact on marine ecosystems. *Science* **319**:948-952
- Halpern B.J. and Warner R.R. (2002) Marine reserves have rapid and lasting effects. *Ecol Lett* **5**:361-366
- Harborne A.R., Mumby P.J., Kappel C.V., Dahlgren C.P., Micheli F., Holmes K.E., Sanchirico J.N., Broad K., Elliot I.A. and Brumbaugh D.R. (2008) Reserve effects and natural variation in coral reef communities. *J Appl Ecol* **45**:1010-1018
- Harmelin-Vivien M., Le Diréach L., Bayle-Sempere J., Charbonnel E., Garcia-Charton J.A., Ody D., Pérez-Ruzafa A., Renones O., Sanchez-Jerez P. and Valle C. (2008) Gradients of abundance and biomass across reserve boundaries in six Mediterranean marine protected areas: Evidence of fish spillover? *Biol Conserv* **141**:1829-1839
- Hawkins J.P. and Roberts C.M. (2004) Effects of artisanal fishing on caribbean coral reefs. *Conserv Biol* **18**:215-226
- Hawkins J.P. and Roberts C.M. (2003) Effects of fishing on sex-changing Caribbean parrotfishes. *Biol Conserv* **115**:213-226
- Hawkins J.P., Roberts C.M., Dytham C., Schelten C. and Nugues M.M. (2006) Effects of habitat characteristics and sedimentation on performance of marine reserves in St. Lucia. *Biol Conserv* **127**:487-499
- Hawkins J.P., Roberts C.M., Gell F.R. and Dytham C. (2007) Effects of trap fishing on reef fish communities. *Aquatic Conservation: Marine and Freshwater Ecosystems* **17**:111-132
- Hillborn R., Stokes K., Maguire J.-J., Smith T., Botsford L.W., Mangel M., Orensanz J., Parma A., Rice J., Bell J., Cochrane K.L., Garcia S., Hall S.J., Kirkwood G.P., Sainsbury K., Stefansson G. and Walter C. (2004) When can marine reserves improve fisheries management? *Ocean Coast Manag* **47**:197-205
- Hsieh C., Reiss C.S., Hewitt R.P. and Sugihara G. (2008) Spatial analysis shows that fishing enhances the climatic sensitivity of marine fishes. *Can J Fish Aquat Sci* **65**:947-961
- Hughes T.P., Baird A.H., Bellwood D.R., Card M., Connoly S.R., Folke C., Grosberg R., Hoegh-Guldberg O., Jackson J.B.C., Kleypas J., Lough J.M., Marshall P., Nyström M., Palumbi S.R., Pandolfi J.M., Rosen B. and Roughgarden J. (2003) Climate change, human impacts, and resilience of coral reefs. *Science* **301**:958-960
- Hughes T.P., Rodrigues M.J., Bellwood D.R., Ceccarelli D., Hoegh-Guldberg O., McCook L., Moltschaniwskij N.A., Pratchett M.S., Steneck R.S. and Willis B. (2007) Phase shifts, herbivory, and resilience of coral reefs to climate change. *Curr Biol* **17**:360-365

- Iborra M.J. (2007) La pêche en Martinique. In: *Rapport du Département thématiques Politiques structurelles et de Cohésion*, p. 23. Parlement Européen
- IUCN (1988) Resolution 17.38 of the 17<sup>th</sup> General Assembly of the IUCN. In, Gland, Switzerland
- Iwata H. and Ukai Y. (2002) SHAPE: A computer program package for quantitative evaluation of biological shapes based on elliptic Fourier descriptors. *J Hered* **93**:384-385
- Jackson J.B.C., Kirby M.X., Berger W.H., Bjorndal K.A., Botsford L.W., Bourque B.J., Bradbury R.H., Cooke R., Erlandson J., Estes J.A., Hughes T.P., Kidwell S., Lange C.B., Lenihan H.S., Pandolfi J.M., Peterson C.H., Steneck R.S., Tegner M.J. and Warner R.R. (2001) Historical overfishing and the recent collapse of coastal ecosystems. *Science* **293**:629-638
- Jennings S., Grandcourt E.M. and Polunin N.V.C. (1995) The effects of fishing on the diversity, biomass and trophic structure of Seychelles' reef fish communities. *Coral Reefs* **14**:225-235
- Jennings S., Greenstreet S.P.R. and Reynolds J.D. (1999) Structural change in an exploited fish community: a consequence of differential fishing effects on species with contrasting life histories. *J Anim Ecol* **68**:617-627
- Jennings S. and Polunin N.V.C. (1997) Impacts of predators depletion by fishing on the biomass and diversity of non-target reef fish communities. *Coral Reefs* **16**:71-82
- Kamukuru A.T., Mgaya Y.D. and Öhman M.C. (2004) Evaluating a marine protected area in a developing country: Mafia Island Marine Park, Tanzania. *Ocean Coast Manag* **47**:321-337
- Kaplan D.M. (2009) Fish life histories and marine protected areas: an odd couple? *Mar Ecol Prog Ser* **377**:213-225
- Katayama S. and Isshiki T. (2007) Variation in otolith macrostructure of Japanese flounder (*Paralichthys olivaceus*): A method to discriminate between wild and released fish. *J Sea Res* **57**:180-186
- Kaufman L.S. (1983) Effects of hurricane Allen on reef fish assemblages near Discovery Bay, Jamaica. *Coral Reefs* **2**:43-47
- Kaunda - Arara B. and Rose G.A. (2004) Effects of marine reef National Park on fishery CPUE in coastal Kenya. *Biol Conserv* **118**:1-13
- Koslow J.A., Hanley F. and Wicklund R. (1988) Effects of fishing on reef fish communities at Pedro Bank and Port Royal Cays, Jamaica. *Mar Ecol Prog Ser* **43**:201-212

- Kuhl F.P. and Giardina C.R. (1982) Elliptic Fourier Features of a Closed Contour. *Comput Graph Image Process* **18**:236-258
- Kulbicki M., Sarramégn S., Letourneur Y., Wantiez L., Galzin R., Mou-Tham G., Chauvet C. and Thollot P. (2007) Opening of an MPA to fishing: Natural variations in the structure of a coral reef fish assemblage obscure changes due to fishing. *J Exp Mar Biol Ecol* **353**:145-163
- L'Abée-Lund J.H. (1988) Otolith shape discriminates between juvenile Atlantic salmon, *Salmo salar* L., and brown trout, *Salmo trutta* L. *J Fish Biol* **33**:899-903
- Lambert Y. and Dutil J.-D. (1997) Condition and energy reserves of Atlantic cod (*Gadus morhua*) during the collapse of the Gulf of St. Lawrence stock. *Can J Fish Aquat Sci* **54**:2388-2400
- Leach F. and Davidson J. (2001) The use of size-frequency diagrams to characterize prehistoric fish catches and to assess human impact on offshore fisheries. *Int J Osteoarchaeol* **11**:150-162
- Lenfant P. (2003) Demographic and genetic structures of white sea bream populations (*Diplodus sargus*, Linnaeus, 1758) inside and outside a Mediterranean marine reserve. *C.R. Biologies* **326**:751-760
- Lou D.C. and Moltschaniwskyj N.A. (1992) Daily otolith increments in juvenile tropical parrotfishes and surgeonfishes. *Aust J Mar Freshw Res* **43**:973-981
- Louis M., Bouchon C. and Bouchon - Navaro Y. (1995) Spatial and temporal variations of mangrove fish assemblages in Martinique (French West-Indies). *Hydrobiologia* **295**:275-284
- Luckhurst B.E., Dean J.M. and Reichert M. (2000) Age, growth and reproduction of the lane snapper *Lutjanus synagris* at Bermuda. *Mar Ecol Prog Ser* **203**:255-261
- Lundquist C.J. and Granek E.F. (2005) Strategies for successful marine conservation: Integrating socioeconomic, political, and scientific factors. *Conserv Biol* **19**:1771-1778
- Mahon R. and Hunte W. (2001) Trap mesh selectivity and the management of reef fishes. *Fish Fish* **2**:356-375
- Malvadkar U. and Hastings A. (2008) Persistence of mobile species in marine protected areas. *Fish Res* **91**:69-78
- Maréchal J.-P. (2007) No-take zones as a management tool for artisanal fisheries in Martinique, FWI. In: *Proc Gulf Caribb Fish Inst*, Punta Cana, Dominican Republic

- McClanahan T.R. (1995) A coral reef ecosystem-fisheries model: impacts of fishing intensity and catch selection on reef structure and processes. *Ecol Model* **80**:1-19
- McClanahan T.R. (2000) Recovery of a coral reef keystone predator, *Balistapus undulatus*, in East African marine parks. *Biol Conserv* **94**:191-198
- McClanahan T.R. and Arthur R. (2001) The effects of marine reserves and habitat on populations of East African coral reef fishes. *Ecol Appl* **11**:559-569
- McClanahan T.R. and Graham N.A.J. (2005) Recovery trajectories of coral reef fish assemblages within Kenyan marine protected areas. *Mar Ecol Prog Ser* **294**:241-248
- McClanahan T.R. and Kaunda - Arara B. (1996) Fishery recovery in a coral-reef Marine Park and its effect on the adjacent fishery. *Conserv Biol* **10**:1187-1199
- McClanahan T.R., Marnane M.J., Cinner J.E. and Kiene W.E. (2006a) A comparison of marine protected areas and alternative approaches to coral-reef management. *Curr Biol* **16**:1408-1413
- McClanahan T.R., Muthiga N.A., Kamukuru A.T., Machano H. and Kiambo R.W. (1999) The effects of marine parks and fishing on coral reefs of northern Tanzania. *Biol Conserv* **89**:161-182
- McClanahan T.R., Verheij E. and Maina J. (2006b) Comparing the management effectiveness of a marine park and a multiple-use collaborative fisheries management area in East Africa. *Aquatic Conservation: Marine and Freshwater Ecosystems* **16**:147-165
- Mellin C., Ferraris J., Galzin R., Harmelin-Vivien M., Kulbicki M. and Lison de Loma T. (2008) Natural and anthropogenic influences on the diversity structure of reef fish communities in the Tuamotu Archipelago (French Polynesia). *Ecol Model* **218**:182-187
- Mellin C., Ferraris J., Galzin R., Kulbicki M. and Ponton D. (2006) Diversity of coral reef fish assemblages: Modelling of the species richness spectra from multi-scale environmental variables in the Tuamotu Archipelago (French Polynesia). *Ecol Model* **198**:409-425
- Micheli F. and Halpern B.J. (2005) Low functional redundancy in coastal marine assemblages. *Ecol Lett* **8**:391-400
- Morat F., Betoulle S., Robert M., Thailly A.F., Biagiatti-Risbourg S. and Lecomte-Finiger R. (2008) What can otolith examination tell us about the level of perturbations of Salmonids fish from the Kerguelen Islands? *Ecol Freshw Fish*
- Mosqueira I., Côté I.M., Jennings S. and Reynolds J.D. (2000) Conservation benefits of marine reserves for fish populations. *Anim Conserv* **4**:321-332

- Mouillot D., Culioli J.-M., Pelletier D. and Tomasini J.A. (2008) Do we protect biological originality in protected areas? A new index and application to the Bonifacio Strait Natural Reserve. *Biol Conserv* **141**:1569-1580
- Mumby P.J. (2009) Herbivory versus corallivory: are parrotfish good or bad for Caribbean coral reefs? *Coral Reefs*
- Mumby P.J., Dahlgren C.P., Harborne A.R., Kappel C.V., Micheli F., Brumbaugh D.R., Holmes K.E., Mendes J.M., Broad K., Sanchirico J.N., Buch K., Box S., Stoffle R.W. and Gill A.B. (2006) Fishing, trophic cascades, and the process of grazing on coral reefs. *Science* **311**:98-101
- Munday P.L., Jones G.J., Pratchett M.S. and Williams A.J. (2008) Climate change and the future for coral reef fishes. *Fish Fish* **9**:261-285
- Munro J.L. (1983) *Caribbean coral reef fishery resources*. ICLARM Studies and Reviews 7, 276p, Manila, Philippines.
- Murawski S., Wigley S.E., Fogarty M.J., Rago P.J. and Mountain D.G. (2005) Effort distribution and catch patterns adjacent to temperate MPAs. *ICES J Mar Sci* **62**:1150-1167
- Myers R.A. and Worm B. (2003) Rapid worldwide depletion of predatory fish communities. *Nature* **423**:280-283
- Nguyen L.V. and Phan H.K. (2008) Distribution and factors influencing on structure of reef fish communities in Nha Trang Bay Marine Protected Area, South-Central Vietnam. *Environ Biol Fishes* **82**:309-324
- Núñez Lara E. and Arias Gonzalez E. (1998) The relationship between reef fish community structure and environmental variables in the southern Mexican Caribbean. *J Fish Biol* **53**:209-221
- Ojeda-Martinez C., Bayle-Sempere J.T., Sanchez-Jerez P., Forcada A. and Valle C. (2007) Detecting conservation benefits in spatially protected fish populations with meta-analysis of long-term monitoring data. *Mar Biol* **151**:1153-1161
- OMMM (2009) Base de données cartographiques des fonds marins côtiers de la Martinique: Biocénoses benthiques. *Rapport technique*:76p
- Oracion E.G., Miller M.L. and Christie P. (2005) Marine protected areas for whom? Fisheries, tourism and solidarity in a Philippine community. *Ocean Coast Manag* **48**:393-410
- Panfili J., de Pontual H., Troadec H. and Wright P.J. (2002) Manuel de sclérochronologie des poissons. *Coédition Ifremer-IRD*:464 p.

- Parnell P.E., Lennert-Cody C.E., Geelen L., Stanley L.D. and Dayton P.K. (2005) Effectiveness of a small marine reserve in southern California. *Mar Ecol Prog Ser* **296**:39-52
- Pauly D. (1995) Anecdotes and the shifting baseline syndrome of fisheries. *Trends Ecol Evol* **10**:430
- Pauly D. (2009) Beyond duplicity and ignorance in global fisheries. *Sci Mar* **73**:215-224
- Pauly D. (1996) One hundred million tonnes of fish, and fisheries research. *Fish Res* **25**:25-38
- Pauly D., Alder J., Christensen V., Tyedmers P. and Watson R. (2003) The future for fisheries. *Science* **302**:1359-1361
- Pauly D., Christensen V., Guénette S., Pitcher T.J., Sumaila U.R., Walters C.J., Watson R. and Zeller D. (2002) Towards sustainability in world fisheries. *Nature* **418**:689-695
- Pauly D. and Froese R. (1991) Fishbase: assembling formation on fish. *NAGA, ICLARM Q* **14**:10-11
- Pauly D. and Watson R. (2005) Background and interpretation of "Marine Trophic Index" as a measure of diversity. *Philos Trans R Soc Lond B Biol Sci* **360**:415-423
- Pauly D., Watson R. and Alder J. (2005) Global trends in world fisheries: impacts on marine ecosystems and food security. *Philos Trans R Soc Lond B Biol Sci* **360**:5-12
- Pérez-Ruzafa A., Gonzales-Wangüemert M., Lenfant P., Marcos C. and Garcia-Charton J.A. (2006) Effects of fishing protection on the genetic structure of fish populations. *Biol Conserv* **129**:244-255
- Perry A.L., Low P.J., Ellis J.R. and Reynolds J.D. (2005) Climate change and distribution shifts in marine fishes. *Science* **308**:1912-1915
- Petursdottir G., Begg G.A. and Marteinsdottir G. (2006) Discrimination between Icelandic cod (*Gadus morhua* L.) populations from adjacent spawning areas based on otolith growth and shape. *Fish Res* **80**:182-189
- Polunin V.C. and Roberts C.M. (1993) Greater biomass and value of target species coral reef fishes in two small Caribbean marine reserves. *Mar Ecol Prog Ser* **100**:167-176
- Ponton D. (2006) Is geometric morphometrics efficient for comparing otolith shape of different fish species? *J Morphol* **267**:750-757
- Pope J.G., Sheperd J.G. and Webb J. (1994) Successful surfriding on size spectra: the secret of survival in the sea. *Philos Trans R Soc Lond B Biol Sci* **343**:41-49
- Popper A.N., Ramcharitar J. and Campana S.E. (2005) Why otoliths? Insights from inner ear physiology and fisheries biology. *Mar Freshw Res* **56**:497-504

- Pothin K. (2005) Analyse de la dispersion larvaire des poissons récifaux à la Réunion à travers l'étude de leurs otolithes. *Thèse de l'Université de la Réunion*:236p
- Pothin K., Gonzalez-Salas C., Chabanet P. and Lecomte-Finiger R. (2006) Distinction between *Mulloidichthys flavolineatus* juveniles from Reunion Island and Mauritius Island (south-west Indian Ocean) based on otolith morphometrics. *J Fish Biol* **69**:38-53
- Rakitin A. and Kramer D.L. (1996) Effect of a marine reserve on the distribution of coral reef fishes in Barbados. *Mar Ecol Prog Ser* **131**:97-113
- Ramdine G. (2004) La pêche en Martinique et en Dominique: étude comparative. Publibook Edition/Collection Sciences Humaines et Géographie.
- Rätz H.-J. and Lloret J. (2003) Variation in fish condition between Atlantic cod (*Gadus morhua*) stocks, the effect on their productivity and management implications. *Fish Res* **60**:369-380
- Rick T.C. and Erlandson J.M. (2000) Early Holocene fishing strategies on the California coast: evidence from CA-SBA-2057. *J Archaeol Sci* **27**:621-633
- Roberts C.M. (1995) Rapid build-up of fish biomass in a Caribbean marine reserve. *Conserv Biol* **9**:815-826
- Roberts C.M., Bohnsack J.A., Gell F.R., Hawkins J.P. and Goodridge R. (2001) Effects of marine reserves on adjacent fisheries. *Science* **294**:1920-1923
- Roberts C.M., Branch G., Bustamante R.H., Castilla J.C., Dugan J., Halpern B.J., Lafferty K.D., Leslie H., Lubchenco J., McArdle D., Ruckelshaus M. and Warner R.R. (2003) Application of ecological criteria in selecting marine reserves and developing reserve networks. *Ecol Appl* **13**:S215-S228
- Robertson D.R., Choat J.H., Posada J.M., Pitt J. and Ackerman J.L. (2005) Ocean surgeonfish *Acanthurus bahianus*. II. Fishing effects on longevity, size, abundance. *Mar Ecol Prog Ser* **295**:245-256
- Robichaud D., Hunte W. and Chapman M.R. (2000) Factors affecting the catchability of reef fishes in Antillean fish traps. *Bull Mar Sci* **67**:831-844
- Robichaud D., Hunte W. and Oxenford H.A. (1999) Effects of increased mesh size on catch and fishing power of coral reef fish traps. *Fish Res* **39**:275-294
- Russ G.R. and Alcala A.C. (1989) Effects of intense fishing pressure on an assemblage of coral reef fishes. *Mar Ecol Prog Ser* **56**:13-27
- Russ G.R. and Alcala A.C. (1998) Natural fishing experiments in marine reserves 1983-1993: roles of life history and fishing intensity in family responses. *Coral Reefs* **17**:399-416

- Russ G.R., Alcalá A.C. and Maypa A.P. (2003) Spillover from marine reserves: the case of *Naso vlamingii* at Apo Island, the Philippines. *Mar Ecol Prog Ser* **264**:15-20
- Russ G.R., Stockwell B. and Alcalá A.C. (2005) Inferring versus measuring rates of recovery in no-take marine reserves. *Mar Ecol Prog Ser* **292**:1-12
- Russ G.R. and Zeller D.C. (2003) From *Mare Liberum* to *Mare Reservarum*. *Mar Policy* **27**:75-78
- Seytre C. and Francour P. (2008) Is the Cape Roux marine protected area (Saint-Raphaël, Mediterranean Sea) an efficient tool to sustain artisanal fisheries? First indication from visual censuses and trammel net sampling. *Aquat Living Resour* **21**:297-305
- Stansky C., Murta A.G., Schlickeisen J. and Zimmermann C. (2007) Otolith shape analysis is a tool for stock separation of horse mackerel (*Trachurus trachurus*) in the Northeast Atlantic and Mediterranean. *Fish Res*
- Stefansson G. and Rosenberg A.A. (2005) Combining control measures for more effective management of fisheries under uncertainty: quotas, effort limitation and protected areas. *Philos Trans R Soc Lond B Biol Sci* **360**:133-146
- Stelzenmüller V., Maynou F., Bernard G., Cadiou G., Camilleri M., Crec'hriou R., Criquet G., Dimech M., Esparza O., Higgins R., Lenfant P. and Pérez-Ruzafa A. (2008) Spatial assessment of fishing effort around European marine reserves: Implications for successful fisheries management. *Mar Pollut Bull* **56**:2018-2026
- Stelzenmüller V., Maynou F. and Martin P. (2007) Spatial assessment of benefits of a coastal Mediterranean Marine Protected Area. *Biol Conserv* **136**:571-583
- Tracey S.R., Lyle J.M. and Duhamel G. (2006) Application of elliptical Fourier analysis of otolith form as a tool for stock identification. *Fish Res* **77**:138-147
- Tupper M.H. and Juanes F. (1999) Effects of a marine reserve on recruitment of grunts (Pisces: Haemulidae) at Barbados, West Indies. *Environ Biol Fishes* **55**:53-63
- Tuset V.M., Lombarte A., Gonzales B.J., Pertusa J.F. and Lorente M.J. (2003a) Comparative morphology of the sagittal otolith in *Serranus* spp. *J Fish Biol* **63**:1491-1504
- Tuset V.M., Lozano I.J., Gonzales J.A., Pertusa J.F. and Garcia-Diaz M.M. (2003b) Shape indices to identify regional differences in otolith morphology of comber, *Serranus cabrilla* (L., 1758). *J Appl Ichthyol* **19**:88-93
- Tuya F., Ortega-Borges L., Sanchez-Jerez P. and Haroum R.J. (2006) Effect of fishing pressure on the spatio-temporal variability of the parrotfish, *Sparisoma cretense* (Pisces: Scaridae), across the Canarian Archipelago (eastern Atlantic). *Fish Res* **77**:24-33



- Underwood A.J. (1981) Techniques of analysis of variance in experimental marine biology and ecology. *Oceanography and Marine Biology. An Annual Review* **19**:513-605
- van Rooij J.M., Bruggemann J.H., Videler J.J. and Breeman A.M. (1995) Plastic growth of the herbivorous reef fish *Sparisoma viride*: field evidence for a trade-off between growth and reproduction. *Mar Ecol Prog Ser* **122**:93-105
- Wantiez L., Thollot P. and Kulbicki M. (1997) Effects of marine reserves on coral reef fish communities from five islands in New Caledonia. *Coral Reefs* **16**:215-224
- Webster P.J., Holland G.J., Curry J.A. and Chang H.R. (2005) Changes in tropical cyclone number and intensity in a warming environment. *Science* **309**:1844-1846
- White C., Kendall B.E., Gaines S., Siegel D.A. and Costello C. (2008) Marine reserve effects on fishery profit. *Ecol Lett* **11**:370-379
- Williams I.D., Walsh W.J., Claisse J.T., Tissot B.N. and Stamoulis K.A. (2009) Impacts of a Hawaiian marine protected area network on the abundance and fishery sustainability of the yellow tang, *Zebrasoma flavescens*. *Biol Conserv*:1066-1073
- Willis T.J. and Anderson M.J. (2003) Structure of cryptic reef fish assemblages: relationships with habitat characteristics and predator density. *Mar Ecol Prog Ser* **257**:209-221
- Willis T.J., Millar R.B. and Babcock C.B. (2000) Detection of spatial variability in relative density of fishes: comparison of visual census, angling and baited underwater video. *Mar Ecol Prog Ser* **198**:249-260
- Wing S.R. and Wing E.S. (2001) Prehistoric fisheries in the Caribbean. *Coral Reefs* **20**:1-8
- Woodley J.D., Chornesky E.A., Clifford P.A., Jackson J.B.C., Kaufman L.S., Knowlton N., Lang J.C., Pearson M.P., Porter J.W., Rooney M.C., Rylaarsdam K.W., Tunnicliffe V.J., Wahle C.M., Wuff C.M., Curtis A.S.G., Dallmeyer M.D., Jupp B.P., Koehl M.R., Neigel J.E. and Sides E.M. (1981) Hurricane Allen's impact on Jamaican coral reefs. *Science* **214**:749-755
- Zeller D., Stoule S.L. and Russ G.R. (2003) Movements of reef fishes across marine reserve boundaries: effects of manipulating density gradients. *Mar Ecol Prog Ser* **254**:269-280

# ANNEXES

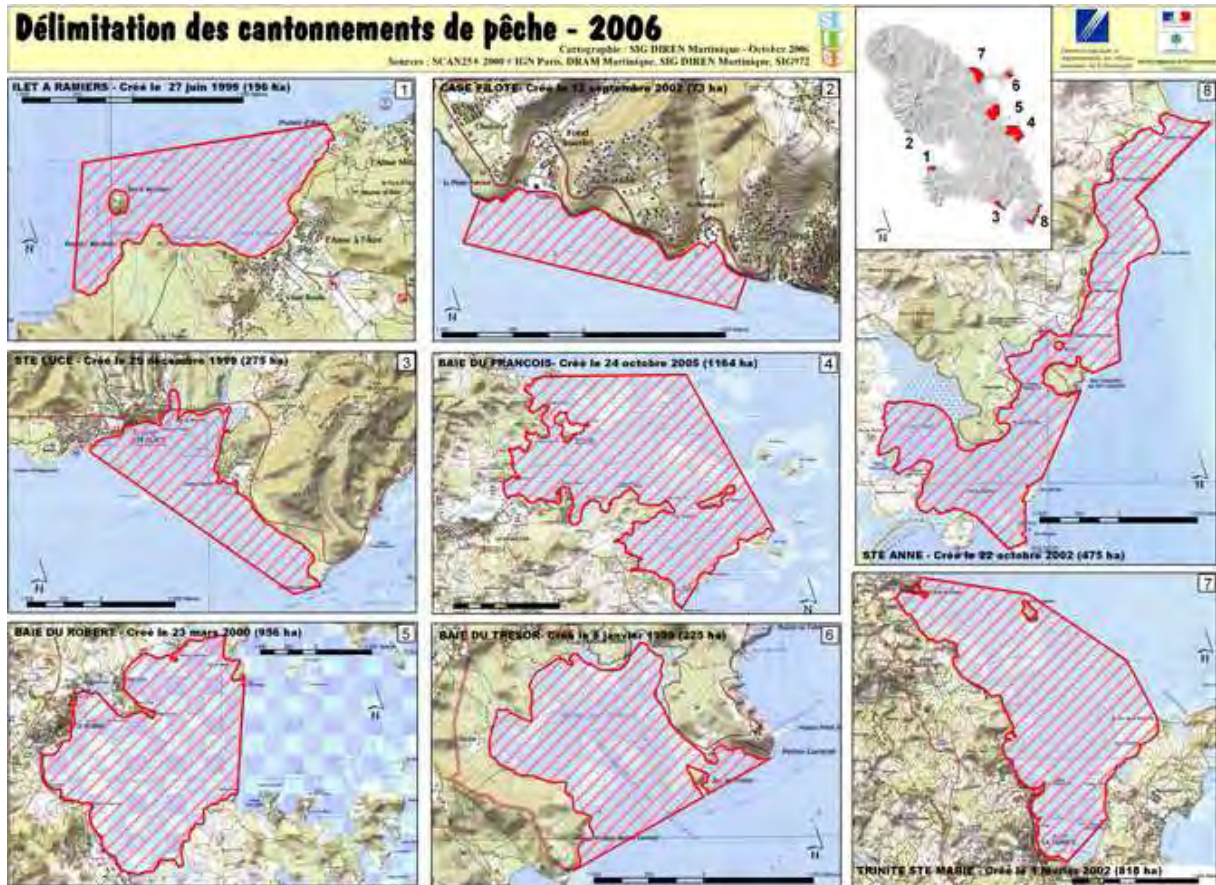
**Annexe 1 :** Délimitation des cantonnements de pêche à la Martinique

**Annexe 2 :** Liste des espèces pêchées

# ANNEXE I

## DÉLIMITATION DES CANTONNEMENTS DE PÊCHE

### A LA MARTINIQUE



**ANNEXE II**  
**LISTE DES ESPÈCES PÊCHÉES**

List of the species ( *A.*: *Acanthostracion*) caught during the experimental fishing with the fishing location (Car: Caribbean, Atl: Atlantic), the fishing value, the trophic group (Macrocarviv: macrocarnivorous, Microcarviv: microcarnivorous) and the mobility group (Se: sedentary, Mo: mobile).

Family	Species	Location	Fishing value	Traps target species	Trophic group	Mobility
Acanthuridae	<i>Acanthurus bahianus</i>	both	Low	yes	Herbivorous	Se
Acanthuridae	<i>Acanthurus chirurgus</i>	both	Low	yes	Herbivorous	Se
Acanthuridae	<i>Acanthurus coeruleus</i>	both	Low	yes	Herbivorous	Se
Scaridae	<i>Sparisoma aurofrenatum</i>	both	High	yes	Herbivorous	Mo
Scaridae	<i>Sparisoma chrysopterygum</i>	both	High	yes	Herbivorous	Mo
Scaridae	<i>Sparisoma viride</i>	both	High	yes	Herbivorous	Mo
Scaridae	<i>Sparisoma radians</i>	Car	None		Herbivorous	Se
Scaridae	<i>Scarus vetula</i>	Car	High	yes	Herbivorous	Mo
Scaridae	<i>Scarus iseri</i>	both	Medium	yes	Herbivorous	Mo
Scaridae	<i>Scarus taeniopterus</i>	both	Medium	yes	Herbivorous	Mo
Scaridae	<i>Scarus guacamaia</i>	Atl	High	yes	Herbivorous	Mo
Lutjanidae	<i>Lutjanus synagris</i>	both	High	yes	Macrocarviv	Mo
Lutjanidae	<i>Lutjanus griseus</i>	both	High	yes	Macrocarviv	Mo
Lutjanidae	<i>Lutjanus jocu</i>	both	High	yes	Macrocarviv	Mo
Lutjanidae	<i>Lutjanus apodus</i>	both	High	yes	Macrocarviv	Mo
Lutjanidae	<i>Lutjanus bucanella</i>	Car	High	yes	Macrocarviv	Mo
Lutjanidae	<i>Lutjanus mahogany</i>	Car	High	yes	Macrocarviv	Mo
Lutjanidae	<i>Ocyurus chrysurus</i>	both	High	yes	Macrocarviv	Mo
Haemulidae	<i>Haemulon flavolineatum</i>	both	Low	yes	Microcarviv	Mo
Haemulidae	<i>Haemulon chrysargyreum</i>	both	Low	yes	Microcarviv	Mo
Haemulidae	<i>Haemulon plumierii</i>	both	Medium	yes	Microcarviv	Mo

Haemulidae	<i>Haemulon aurolineatum</i>	both	Low	yes	Microcarniv	Mo
Haemulidae	<i>Haemulon album</i>	Atl	Medium	yes	Microcarniv	Mo
Haemulidae	<i>Haemulon carbonarium</i>	both	Medium	yes	Microcarniv	Mo
Haemulidae	<i>Haemulon sciurus</i>	Car	Medium	yes	Microcarniv	Mo
Serranidae	<i>Epinephelus guttatus</i>	both	High	yes	Piscivorous	Se
Serranidae	<i>Epinephelus striatus</i>	Atl	High	yes	Piscivorous	Se
Serranidae	<i>Epinephelus morio</i>	Atl	High	yes	Piscivorous	Se
Serranidae	<i>Cephalopholis fulva</i>	both	High	yes	Piscivorous	Se
Serranidae	<i>Cephalopholis cruentatus</i>	Car	High	yes	Piscivorous	Se
Serranidae	<i>Mycteroperca venenosa</i>	Car	High	yes	Piscivorous	Se
Holocentridae	<i>Holocentrus rufus</i>	both	Low	yes	Microcarniv	Se
Holocentridae	<i>Holocentrus adscensionis</i>	both	Low	yes	Microcarniv	Se
Holocentridae	<i>Myripristis jacobus</i>	both	None		Plankton feeder	Se
Holocentridae	<i>Neoniphon marianus</i>	Car	None		Microcarniv	Se
Mullidae	<i>Pseudupeneus maculatus</i>	Car	Medium	yes	Microcarniv	Se
Mullidae	<i>Mulloidichthys martinicus</i>	Car	Medium	yes	Microcarniv	Se
Carangidae	<i>Caranx ruber</i>	Atl	Low	no	Piscivorous	Mo
Sparidae	<i>Calamus calamus</i>	Atl	Low	yes	Microcarniv	Mo
Carangidae	<i>Caranx crysos</i>	Atl	Low	no	Piscivorous	Mo
Carangidae	<i>Caranx latus</i>	Atl	Low	no	Piscivorous	Mo
Gerreidae	<i>Eucinostomus gula</i>	Atl	Low	no	Microcarniv	Se
Labridae	<i>Bodianus rufus</i>	Car	Medium	no	Macrocarv	Se
Balistidae	<i>Catherhines pullus</i>	Car	Low	no	Microcarniv	Se
Scorpaenidae	<i>Scorpaena plumieri</i>	Car	Medium	no	Piscivorous	Se
Diodontidae	<i>Diodon holocanthus</i>	Car	none		Microcarniv	Se
Pomacentridae	<i>Stegastes planifrons</i>	Car	none		Plankton feeder	Se
Pomacentridae	<i>Stegastes dienaecus</i>	Car	none		Plankton feeder	Se
Pomacentridae	<i>Abudefduf saxatilis</i>	both	none		Plankton feeder	Se
Ostraciidae	<i>A. quadricornis</i>	both	none		Microcarniv	Se
Ostraciidae	<i>A. polygonia</i>	Car	none		Microcarniv	Se

Chaetodontidae	<i>Chaetodon capistratus</i>	both	None	Microcarniv	Se
Chaetodontidae	<i>Chaetodon striatus</i>	both	None	Plankton feeder	Se
Chaetodontidae	<i>Chaetodon ocellatus</i>	Car	None	Microcarniv	Se
Sciaenidae	<i>Equetus punctatus</i>	Car	none	Microcarniv	Se

---